



Reliable Ultrasonic Measurement



Hand-Held Multi-Mode Ultrasonic Thickness Gauge

Operating Manual



Covers Mk5 Gauge Models :

Cygnus 2 / 2+
Cygnus 3+ / 3+ Pro
Cygnus 4 / 4+ / 4+ Pro
Cygnus 6+ Pro

Doc No. M5-SG User Manual (Issue 19).docx
19 September 2024

For Firmware Version 5.33 onwards

Contents

1. Important Notice	8
2. Introduction.....	9
Cygnus Mk5 Thickness Gauge.....	9
Register your Gauge	10
Cygnus Instruments.....	11
Contact Details	11
Gauge Kit Contents	12
Basic Gauge Kit	12
Kit supplied with Single Element Probes	12
Kit supplied with Twin Element Probes	12
3. Gauge Models & Features.....	13
4. Gauge Preparation	14
Fitting the Batteries	14
Micro SD card Location	15
Connecting the Probe	16
Fitting the Neck Strap	17
5. Selecting the Right Probe.....	18
Measuring Metals.....	18
Measurement Modes Explained and Compared	19
Multiple Echo Mode (ME) (Mode 3).....	19
Single Echo Mode (SE) (Mode 2)	19
Echo-Echo Mode (EE) (Mode 3)	20
Measuring Non-Steels	21
Measuring Non-Metals	21
Single Element Probes and Protective Membranes.....	22
Summary of Cygnus Probes	25
Twin Element probes	25
Single Element probes	26
The 'Probe Type' Code	26
6. Gauge Operation	27
Gauge Controls	27
Turning the Gauge On	28
Turning the Gauge Off.....	28
Automatic Power Off.....	29
Measurement Screen Views.....	29
Status Information.....	30

End Display for Measurements	31
Taking Thickness Measurements	31
Zeroing the Probe (twin element probes)	31
Taking the Thickness Measurement.....	31
Echo Indicators in Multiple Echo Mode	32
Measurement Stability Indication in SE & EE Modes.....	33
Measuring Small Diameter Pipe & Tubes.....	34
Display Hold Feature	35
Battery Life.....	36
Battery Level.....	36
Low Battery Indication.....	36
7. Using the A-Scan Display	38
Single Echo Mode	38
Measuring Over Corrosion Pits	39
Echo-Echo Mode	40
Multiple Echo Mode	41
8. Calibration	43
Why should I Calibrate my Thickness Gauge?.....	43
Calibration Options	44
Calibrating to a known thickness (Single or 1 Point).....	44
Two Point Calibration	46
Ladder Step Wedge	46
Two Point Calibration Procedure	47
Probe Zero (twin element probes)	49
Starting a Probe Zero from the Main Menu	50
Probe Zero.....	50
Setting the Velocity of Sound	51
9. Gauge Setup	53
Menu Operation.....	53
Settings are Saved with the Probe Type	54
Inputting Numeric Values using the Navigation Keys	55
Inputting Text using the Navigation Keys	55
Selecting the Probe Type	57
Confirming the Probe Type when Connected.....	57
Changing the Probe Type	57
Automatic Probe Detection	58
Measurement Units	59
Resolution Setting	60
Limit & Alarm Feature	61

Setting the Limit Feature.....	63
Deep Coat Feature (multiple echo mode).....	64
10. High Temperature Measurement.....	66
T5BH High Temperature Probe.....	66
Velocity Change Compensation	67
Temperature Compensation Feature	68
Taking Measurements at High Temperatures.....	69
High Temperature Couplant.....	70
11. Cross-Section B-Scan Feature.....	71
Scan Menu Options	72
Range	72
Scan Length.....	72
Performing a Scan	72
12. Data Logging	75
Record Types	75
Reference and Minimum Thicknesses	75
Minimum Thickness Limit Alert.....	76
Radial Points.....	76
Measurement Comments	77
Loading Measurement Comments from a File	78
Grid Records.....	78
Template Records.....	80
Data Logging Menu	80
Creating a new Record	80
Your Choices will be Saved for Next Time	82
Using a Template to Create a new Record.....	83
User Field Input.....	83
Reviewing and Editing User Field Choices.....	83
Logging Thickness Measurements.....	84
Auto-Log Feature	85
Logging Obstructions and No-Readings.....	86
Changing Measurement Units while Data Logging.....	87
Re-taking the Last Measurement.....	87
Stepping Backwards in the Record.....	88
Adding Radial Points	89
Adding Measurement Comments	91
Closing and Opening a Record	93
Closing the Record	93
Opening a Record	93

Protecting a Record.....	94
Opening Protected Records.....	96
Deleting Records	96
Deleting Individual Records	97
Deleting All Records	98
Record Status.....	98
13. Data Logging Templates	100
Templates	100
Integrating with Microsoft Excel	101
Measurement Points.....	101
User Fields	102
User Field 'List' Type	102
14. Manual Gain Adjustment.....	104
Manual Gain Mode	104
Turning on Manual Gain	104
Manual Gain Menu	105
Adjusting the Gain	106
Adjusting the Range	107
Measuring Below the Probes Minimum Thickness Specification	108
15. Setup Menu.....	109
A-Scan Range	109
Automatic.....	109
Manual	109
Vibrate Feature	109
Brightness Setting	110
Bluetooth®.....	110
Bluetooth Adapters	110
Turning Bluetooth On	111
Pairing with a Computer.....	111
Finding the COM Port Assigned.....	113
End Display	114
Rotate (End Display)	114
Power Off Setting	114
Auto-Log	114
Temp Units.....	114
Comments.....	114
Set Time and Set Date	115
16. General Points on Thickness Gauging	116
17. Troubleshooting.....	117

The Gauge will not Switch On	117
Difficulty obtaining a Reading	117
If Readings are Erratic or Unstable	117
Tips for Optimising Battery Life	117
18. Updating the Gauge	119
Update the Firmware.....	119
Gauge Firmware Files	119
Upgrading the Gauge Model	120
Entering the Upgrade Code.....	120
19. Care and Servicing	122
Cleaning the Gauge.....	122
Batteries	122
Environmental.....	122
Repairs	122
Returning the Gauge for Servicing.....	123
20. CygLink Computer Software	124
Installing CygLink	125
Requirements.....	125
Upgrading.....	125
Installing	125
Connecting to the Gauge	125
First time USB Connection	125
Connecting the Gauge to CygLink for the First Time	126
Connecting using Bluetooth	127
Connecting to the Gauge Afterwards	128
Disconnecting from the Gauge	128
Manual Connection Settings.....	128
Status Bar	128
Surveys	129
Creating a new Survey.....	129
Opening an Existing Survey	130
Editing the Survey Info	130
Managing the Survey	130
Sorting Survey Records	130
Viewing Record Information.....	131
Ref and Min Thickness	132
Protection State.....	133
Measurement Summary Stats	133
Data Logger Records	133

Transferring Records from the Gauge	133
Viewing Thickness Measurements in a Record.....	135
Managing Measurements.....	135
Viewing Measurement Information.....	136
Adding Comments to Measurements	137
Viewing an A-Scan Graph	138
Deleting all Records from the Gauge	139
B-Scans	140
Transferring B-Scans from the Gauge.....	140
B-Scan Menu.....	141
Viewing a B-Scan Graph.....	142
Viewing a B-Scan Information.....	143
Exporting the B-Scan to a CSV File	144
Measurement Comment List	145
Material Velocity List	146
Creating a PDF Survey Report	148
Exporting a Survey to a CSV File.....	149
Templates	150
Creating New Templates	150
Editing Templates	151
Sending Templates to the Gauge.....	154
Deleting Templates from the Gauge	155
Other Features	155
Setting the Time and Date on the Gauge	155
COM Port Numbers	155
Finding your COM Port Number	155
21. Information	157
Technical Specifications	157
Table of Sound Velocities	161
Reading Conversions	162
22. Recycling and Disposal (EC Countries).....	163
23. Warranty Information.....	164
24. Index	166

1. Important Notice



This following important information must be read and understood by all users of Cygnus ultrasonic thickness gauges.

The correct use of Cygnus ultrasonic thickness gauges requires identification of the correct equipment for the specific application coupled with an appropriately trained and qualified operator or technician. The incorrect use of this equipment, along with its incorrect calibration, can result in serious financial loss due to damage to components, facilities, personal injury and even death.

Neither Cygnus Instruments nor any of its employees or representatives can be held responsible for improper use of this equipment. Proper training, a complete understanding of ultrasonic wave propagation, thorough reading of this manual, proper transducer selection, correct zeroing of the transducer, correct sound velocity, correct use of the appropriate test blocks, proper cable length and proper couplant selection all play a factor in successful ultrasonic thickness gauging. Of critical importance is the process of complete and accurate calibration of the instrument.

This manual will provide instructions in the set up and operation of the thickness gauge. Additional factors that can affect the use of ultrasonic equipment are beyond the scope of this manual and to that end it is understood that the operator of this equipment is a well-trained inspector qualified by either their own organisation or another outside agency to the appropriate level of both theory and practical application of ultrasonics.

Therefore, Cygnus Instruments recommends that users of its ultrasonic thickness gauges should be formally qualified to a minimum of UT "Level 1" (ASNT or PCN) which will provide approximately 40 hours of training.

2. Introduction

Cygnus Mk5 Thickness Gauge

The **Cygnus Mk5 Ultrasonic Thickness Gauge** is a rugged, handheld, battery-powered instrument designed for high-reliability thickness measurements in harsh environments using ultrasound.

It features a side colour LCD display¹ which can be easily read in most light situations including sunlight, and some models have an end mounted display¹ that displays thickness measurements when worn around the neck or in a pocket.

There are a range of models of the Mk5 gauge, each with different levels of features. Gauges can be easily upgraded in the field with a purchased update-code to unlock additional features. *See Gauge Models & Features on page 13.*

The gauge can be used with a choice of Ultrasonic Probes, selected to suit the material and thickness range to be measured.

The gauge can measure material thickness using three methods¹; Single Echo, Echo-Echo or Multiple Echo. Both Echo-Echo and Multiple Echo allow measurements through surface coatings which are also ignored. An A-Scan Display¹ provides the user with information that can be used to visually verify the thickness measurement which can be displayed in Metric (mm) or Imperial (inch) units.

A Data Logging function¹ can save thickness measurements and A-Scans into a record file which can then be transferred to a computer for analysis and report generation.

The gauge can easily be calibrated to a known thickness or to a known Velocity of Sound.

¹ Depending on gauge model.

The gauge is able to operate accurately over a wide range of ambient temperatures and is environmentally sealed to IP67 for use in wet conditions.



The gauge is a solid-state electronic instrument which, under normal operating conditions, will give many years of active service.

Although designed for ease of operation the first-time user should carefully read this manual to familiarise themselves with the features of the Gauge.

Register your Gauge

Register your gauge to receive updates on gauge firmware and to register your 3-year warranty.

Registration is quick and easy, go to this web address;

<https://cygnus-instruments.com/service/product-registration/>



Product Registration Link QR

Cygnus Instruments

Cygnus Instruments Limited, founded in 1983, pioneered the development of the Digital *Ultrasonic Multiple-Echo Technique* used for measurement through coatings. This has long since been the standard required to ensure that accurate measurements are taken without the need to zero the gauge or remove any coatings first.

Our philosophy is to work closely our customers to provide high quality products, engineered to serve heavy industry & harsh environments. Cygnus Ultrasonic thickness gauges are designed to be reliable and simple to use. We have an unrivalled reputation in over 45 countries around the world.

Contact Details

CYGNUS Instruments Ltd.

Cygnus House, 30 Prince of Wales Road,
Dorchester, Dorset, DT1 1PW England.

Website: www.cygnus-instruments.com

Tel: 00 44 (0) 1305 265533

sales@cygnus-instruments.com

For all Cygnus offices and Authorised Cygnus Service Centres and Distributors around the world please refer to the Cygnus website Worldwide Distribution page.

<https://cygnus-instruments.com/about-us/worldwide-distributors/>



Gauge Kit Contents

Basic Gauge Kit

1. Cygnus Gauge fitted with Hand Strap
2. Operating Manual (outer pouch)
3. Neck Strap (inner pouch)
4. Accessory Pouch, containing;
 - 3 x AA Batteries
 - Blue Couplant Gel
 - Membrane Couplant
 - 15mm (or 1/2") Steel Test Block
 - USB Memory Stick with Manual PDF and CygLink Installer (If applicable to gauge).
5. USB Cable (inner pouch)



Kit supplied with Single Element Probes

1. Ultrasonic Probe
2. Moulded Probe Cable (inner pouch)
3. Spare Membranes
4. Membrane Key

Kit supplied with Twin Element Probes

1. Ultrasonic Probe
2. Moulded Probe Cable (inner pouch)

3. Gauge Models & Features

Feature	Model							
	Cygnus 2	Cygnus 2+	Cygnus 3+	Cygnus 3+ Pro	Cygnus 4	Cygnus 4+	Cygnus 4+ Pro	Cygnus 6+ Pro
Single Echo Measurements (SE)		■	■	■		■	■	■
Echo-Echo Measurements (EE)		■		■		■	■	■
Multiple-Echo Measurements (ME)	■	■			■	■	■	■
Deep Coating Measurements in ME	■	■			■	■	■	■
End Display for Measurements	■	■	■	■				■
Side 2.4" Colour Display	□ ²	□ ²	■	■	■	■	■	■
A-Scan Display				□ ³		■	■	■
Manual Gain Control				□ ³		■	■	■
High Temperature Measurement				□ ³		■	■	■
Data Logging (Linear)						■	■	■
Data Logging (Grid, Comments, Radials)							■	■
Measurement Limits					■	■	■	■
Vibrate Alert	■	■		■	■	■	■	■
B-Scan				■				■
Bluetooth								■



In this manual all the features are described, but the features available on your gauge will depend on the model.

² For gauge setup Menu only

³ Additional Feature Option

4. Gauge Preparation

The gauge is supplied ready to use out of the box. Just insert the batteries, connect the probe to the gauge, turn on the power, calibrate and you are ready to begin taking thickness measurements.

Fitting the Batteries

The gauge requires 3 x AA/LR6/UM3 Batteries. Cygnus supplies and recommends Duracell Alkaline batteries. The batteries are located behind a cover on the rear of gauge. The hand strap can be separated by a push-button buckle to gain access to the battery cover. The battery cover is removed by pressing in with your thumb the at the base to release the clip.



Press the bottom of the battery cover to release the retaining clip and lift up the battery cover.



The batteries are located underneath.

The gauge is protected against electrical damage from incorrect battery insertion.

The battery compartment itself is sealed to contain any battery fluids that may leak out.

- ❗ The gauge can be fitted with NiCad or NiMH rechargeable batteries but this may alter the specified operating time.
- ❗ To avoid damage from leaking batteries **always** remove the batteries if the gauge will be unused for any length of time.

If the batteries run flat they may leak acid into the battery compartment and damage the electrical contacts. This would not be covered by the warranty.

Micro SD card Location

The gauge comes fitted with a Micro SD card that is used to store data logger records and B-scan results. Data stored on the card can either be read using the gauges USB connection and CygLink or by removing the card from the gauge and using a computer to read the contents. The Micro SD card is located within the battery compartment underneath the battery below a cover.



Removing the batteries will reveal the Micro SD card cover which can be lifted up to reveal the Micro SD card.

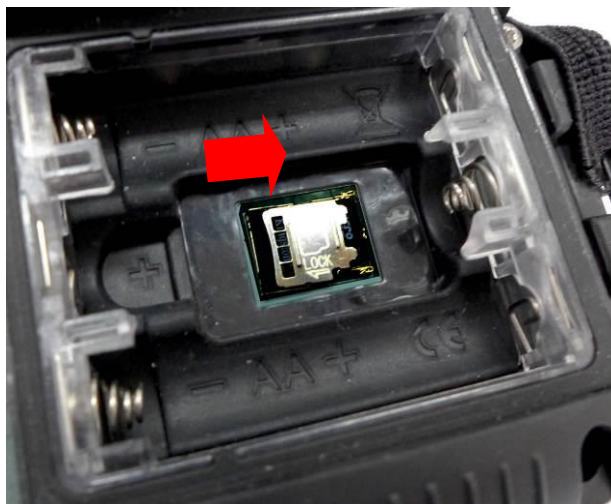

Micro SD card cover removed.

To the remove the card, slide the metal cover in the direction show by the arrow marked "OPEN". The card socket will pop up.

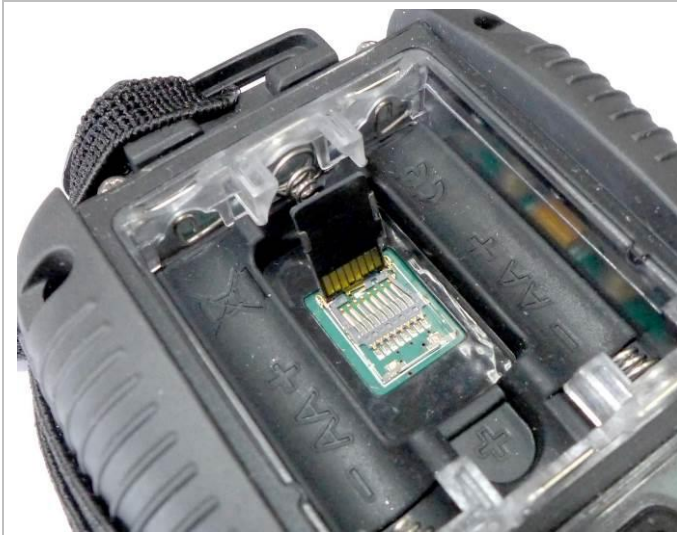

Carefully remove the card by sliding it out.

To refit the card slide it back into the metal flap. Lower the card back down and then slide the metal frame in the direction of "LOCK" arrow.

Connecting the Probe

The Cygnus probe lead uses a custom-made cable that offers superior flexibility and resistance to oils and ultraviolet light. The twin connectors are over-moulded to form a tough housing that will provide a long-lasting probe cable. Depending on the type of probe supplied the probe end will have either a BNC or single/twin Lemo® '00' connector.



The connector is orientated with a 'pip' and can only be plugged in one-way around.

To release the connector, pull back on the connector body. DO NOT pull the cable.

Fitting the Neck Strap

The gauge is supplied with an adjustable Neck Strap. The ends of the neck strap clip onto two wire loops. These wire loops are made from coated stainless steel.



To fit the wire loop to the gauge body, pass the loop through the hole in the gauge and back over the other end.

The neck strap can then be clipped on to these two loops.

5. Selecting the Right Probe

The performance of any thickness gauge and its ability to get a reliable measurement depends on selecting the right ultrasonic probe for the application and conditions. Cygnus gauges are therefore offered with a selection of probes suitable for most thickness gauging applications.

The following section helps you select the right probe for the application.



The gauge **must** be set for the probe connected to it, see Selecting the Probe Type on page 57.

Measuring Metals

Material	Coating	Corrosion	Typical Thickness	Recommended..	
				Probe	Measurement Mode
Steels	Any	Non to Moderate	1 mm+ (0.04"+)	S5A	Multiple Echo
Steels	Any	Non to Moderate	2 mm+ (0.08"+)	S3C	Multiple Echo
Steels	Any	Non to Moderate	3 mm+ (0.12"+)	S2C	Multiple Echo
Steels	Non	Non to Heavy	0.8 mm+ (0.03"+)	T7A	Single Echo
Steels	Non	Non to Heavy	1.5 mm+ (0.06"+)	T5B	Single Echo
Steels	Non	Non to Heavy	1.5mm+ (0.06"+)	T5A	Single Echo
Cast Iron	Non	Non to Moderate	2.5 mm+ (0.1"+)	T2C	Single Echo
Steels	Non	Non to Heavy	1.5mm+ (0.06"+)	T5BH	Single Echo High Temperature (Up to 550C)

The table above shows to be able to measure both coated and un-coated steels with non to heavy corrosion ideally you will require at least two probes, in almost all applications this will be a **S2C** probe and a **T5B** probe.



When measuring in Multiple Echo mode the coating will be ignored and just the metal thickness measured.



It is possible to use a Twin Element (T**) probe in Echo-Echo Mode to ignore thin paint coatings. However, this method does not have the ability to verify measurements and without observing the A-Scan display it is possible to get incorrect measurements.

Measurement Modes Explained and Compared

Multiple Echo Mode (ME) (Mode 3)

Multiple Echo measurement mode is by far the most reliable and quickest method for thickness measurements because it works by looking for three matched echoes it can verify the thickness measurement is valid. This method has been used in all Cygnus gauges since the late 1970s.

Multiple echo mode will ignore surface coatings (Through Coating mode) there is no need to remove the paint to take a measurement.

Also, because it uses a single element (or single crystal) probe there are no errors due to the V-path of the ultrasound beam found in all twin element probes. This makes it simple to calibrate – two-point calibrations are not required.

However, because it requires three echoes to take a measurement, in heavily corroded steels there is often an insufficient number of echoes so measurements may not be possible.

Single Echo Mode (SE) (Mode 2)

Single Echo measurement mode is most useful on heavily corroded metals where Multiple Echo fails. Because it only needs the first

return echo to take a measurement it performs well on virtually all steel conditions.

However single echo mode will not ignore any surface coatings, so if you measure through a coating it will give an incorrect metal thickness measurement. If the surface coating is very thin (0.2mm / 0.01") paint you can make an allowance for this error, but thicker coatings introduce too much error to be practical.

Single echo measurements use a twin element (twin crystal) probe because there are two elements angled to a focal point there is a v-path error introduced. However, this v-path error is mostly corrected by the gauge, and furthermore by performing a two-point calibration.

Twin element probes require "zeroing" at regular intervals, especially if the ambient temperature is changing.

To overcome some of the drawbacks of Single Echo measurements the gauge has an A-Scan display that can be used to visually verify the thickness measurements are sensible and therefore reliable. See section Using the A-Scan Display on page 38.

Echo-Echo Mode (EE) (Mode 3)

Echo-Echo mode uses a twin element probe, but measures between the first two echoes. This method is intended to ignore any thin surface coatings whilst still using a twin element probe.

Echo-echo mode is not able to verify its measurements unlike Multiple echo mode, therefore it is liable to give incorrect readings. But as the gauge offers an A-Scan display you can use this to visually decide if the measurement given is correct.

Echo-echo mode must therefore be used with caution, and only on thin paint surface coatings (less than 0.5mm/0.02"). It is recommended a Single Echo measurement should also be made to help verify the measurement makes sense (the Single Echo measurement should always be thicker due to the coating thickness).

Measuring Non-Steels

The gauge will measure the following non-steels;

- Aluminium alloys
- Copper and Brass alloys
- Titanium

Use the same rules as steels when selecting a suitable probe. The gauge will ideally be re-calibrated to suit the metal being measured, or the standard velocity of sound for that material would be entered into the gauge.

Measuring Non-Metals

You can measure certain types of plastics with the gauge using a twin element probe and the gauge set to Single Echo measurement mode. Generally, the harder the plastic the better, soft materials like rubber or TPEs tend to absorb too much ultrasound so only thin samples can be measured.

Engineering plastics like Acetal, Tufset (Polyurethane), Nylon and High-density polyethylene (HDPE) can be measured successfully.

Rotationally Moulded parts can generally be measured successfully.

- You must use Single Echo mode to measure plastics.
- You must generally use a low frequency probe (the **T2C** probe is recommended) to measure plastics, but this will depend on the properties of the material.
- Any material with a closed-cell construction cannot be measured.
- Any material with internal voids, air bubbles or honeycomb cannot be measured.

Typically, these materials cannot be measured with the gauge;

- Concrete
- Wood
- Thermal insulation materials
- Foams
- Composites

Single Element Probes and Protective Membranes

All Cygnus single element probes have a soft face and are therefore fitted with a Polyurethane Membrane which provides better contact on rough surfaces and protects the probe face from wear and prolonging the life of the probe.



Check the membrane regularly as it is important the membrane is changed as soon as it shows any signs of wear.

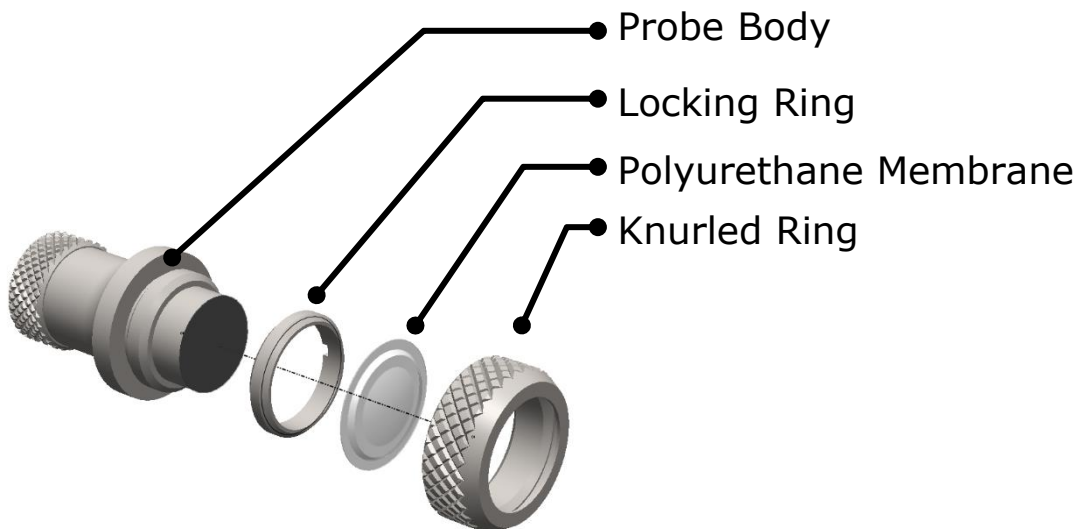



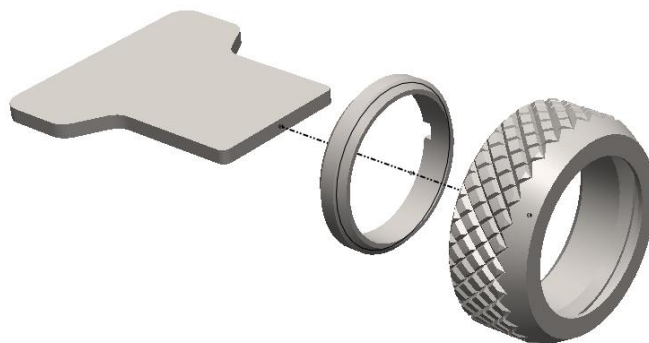

Single Element Probe Membrane Parts.

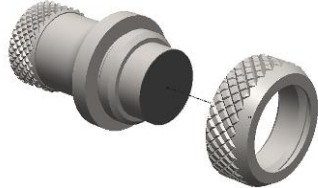
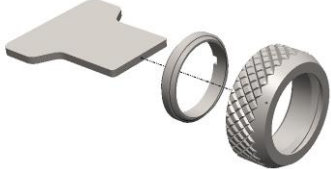
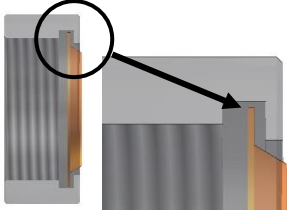
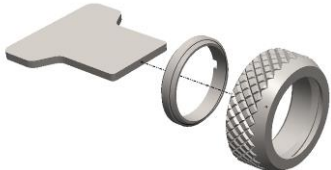

Single Element Probe Membrane Locking Key

Changing the Protective Membrane on Single element Probes

<p>1.</p>	<p>Unscrew the Knurled Ring from the end of the Probe.</p>	
<p>2.</p>	<p>Use the Membrane Key to unscrew the Locking Ring from inside the Knurled Ring. The old membrane can then be removed and discarded.</p>	
<p>3.</p>	<p>Place a new membrane into the end of the Knurled Ring ensuring it locates in the groove.</p>	
<p>4.</p>	<p>Screw the Locking Ring back inside the Knurled Ring and tighten with the Membrane Key.</p>	
<p>5.</p>	<p>Place a few drops of Membrane Couplant on to the probe face.</p>	
<p>6.</p>	<p>Screw the Knurled Ring back onto the probe. Use your thumb to squeeze the couplant from under the membrane as you tighten the Knurled Ring down.</p>	
<p>7.</p>	<p>You should see the membrane has a very thin film of couplant between itself and the probe face with <u>no air bubbles</u>.</p>	

Measuring Higher Temperatures

The polyurethane membranes fitted to the single element probes are suitable for measuring surface temperatures up to **70°C** (160°F). For measuring higher temperatures Teflon membranes are available and suitable for surface temperatures up to **150°C** (300°F) with intermittent contact. Contact Cygnus instruments to order Teflon membranes.

When measuring high temperatures limit the time the probe is in contact with the hot surface to less than 4 seconds and ensure the probe has sufficient time between measurements to cool down.

Summary of Cygnus Probes

Twin Element probes

Probe Type	Size	Frequency	Range in Steel (SE Mode)	Typical Uses
T2C	12mm 0.5"	2 MHz	2.5 to 250 mm 0.1 to 10"	Attenuative materials Cast irons, Plastics
T5B-CSL	8mm 0.32"	5 MHz	1.5 to 200 mm 0.06 to 8"	General purpose Most metals
T5B-CSW	8mm 0.32"	5 MHz	1.5 to 200 mm 0.06 to 8"	General purpose Most metals Note: Smaller probe body than T5B-CSL, fixed cable.
T5A	6.4mm	5MHz	1.5 to 150 mm 0.06 to 6"	General purpose Most metals
T7A	5mm 0.2"	7.5 MHz	0.8 to 50 mm 0.03 to 2"	Thin metals
T5BH	8mm 0.32"	5 MHz	1.5 to 150 mm 0.06 to 8"	High Temperature (Up to 550C)

Single Element probes

Probe Type	Size	Frequency	Range in Steel	Typical Uses
S2C	13mm 0.5"	2.25 MHz	3 to 250 mm 0.12 to 10"	General purpose probe suitable for most applications that can use Multiple Echo measurement. Coated metals
S3C	13mm 0.5"	3.5 MHz	2 to 150 mm 0.08 to 6"	Coated metals
S5C	13mm 0.5"	5.0 MHz	1 to 50 mm 0.04 to 2"	Coated metals
S5A	6mm 0.25"	5.0 MHz	1 to 50 mm 0.04 to 2"	Small diameter tubes Thin metals Coated metals

The 'Probe Type' Code

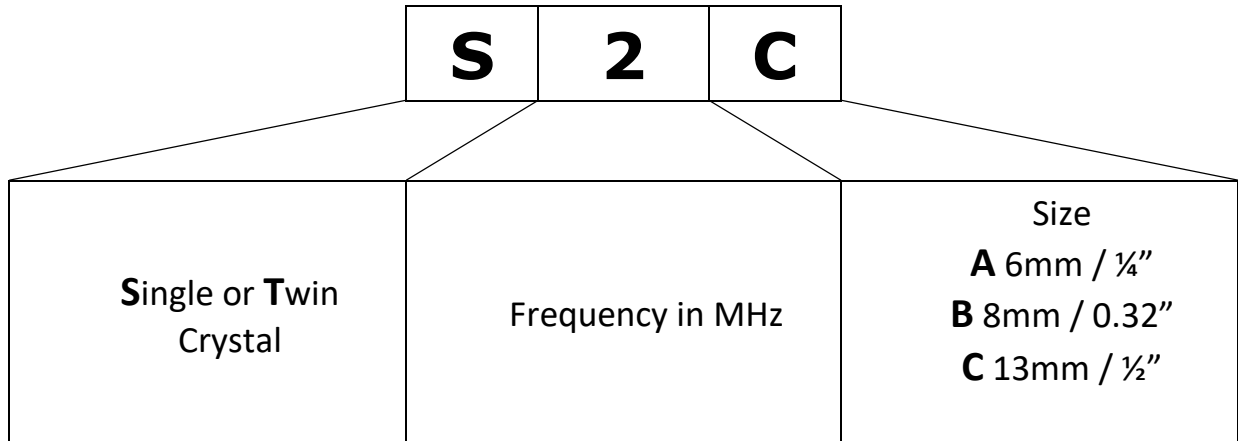

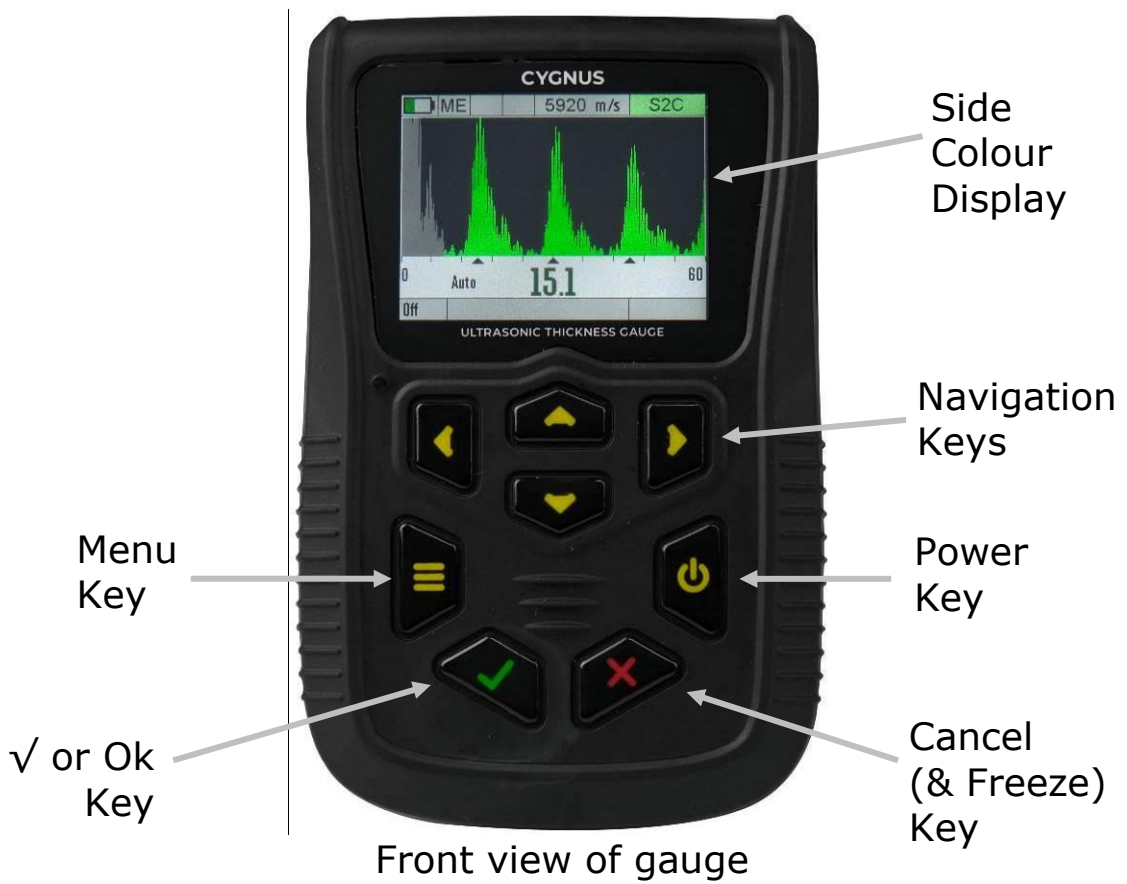

6. Gauge Operation

Gauge Controls

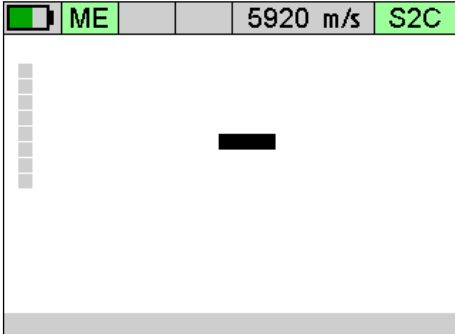

Turning the Gauge On

1.	Press the Power key	
2.	Cygnus Instruments Logo is displayed	
3.	The gauge details are displayed; Model Serial Number Version Number Run Time	
4.	The gauge is ready to use	

Turning the Gauge Off

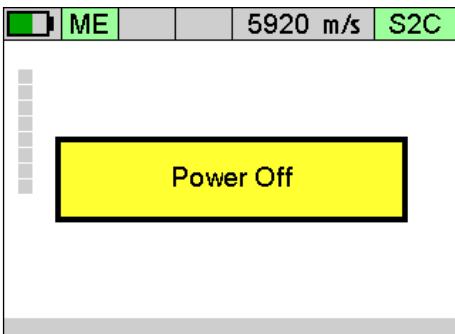
1.	Press & Hold the Power key,	
2.	The display shows 'power-off' and the gauge turns off.	

Automatic Power Off

By default, the gauge will turn off automatically after 5 minutes of in activity.

Taking thickness measurements or accessing the menu will reset the activity timer back to zero.

You can change the activity time value the Setup menu, see Power Off Setting on page 114.

Measurement Screen Views

The gauge has three measurement screens that can be quickly changed using the left and right navigation keys. These screens offer three views to suit the situation.

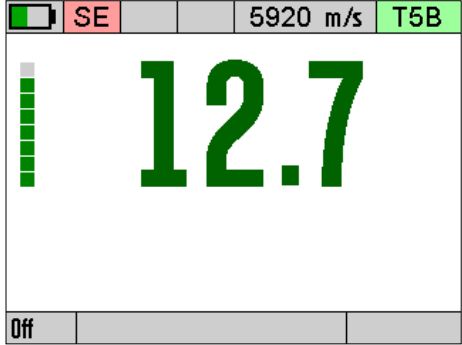
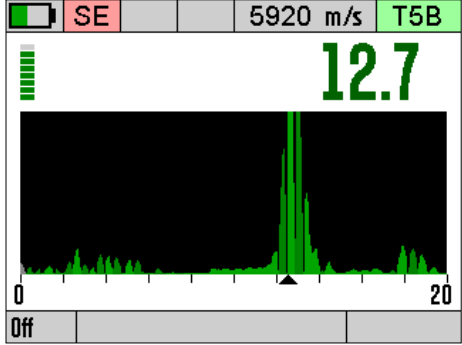
<p>1.</p>	<p>Use the Left and Right navigation keys to move between the three screens</p>	
<p>2.</p>	<p>Basic Screen</p> <p>Just shows a large thickness measurement value.</p>	
<p>3.</p>	<p>A-Scan Screen</p> <p>Show the thickness measurement and a live A-Scan display of the ultrasound signals received.</p>	

4. Data Logging Screen

When data logging is active this screen shows details of logged measurements.

	ME		5920 m/s	S2C
13.90				
Min. 2.55		Max. 15.40		Ave. 12.48
P8				
P7	13.90			
P6	14.00			
P5	2.55			
P4	13.95			
Lin	020315-161425	7/50		

Status Information

At the top of the display is an area that shows information about the gauge's status;

- Battery Level
- Velocity of Sound value / Calibration Status
- Probe Type
- Measurement Mode
- Deep Coat Feature
- Temperature Compensation

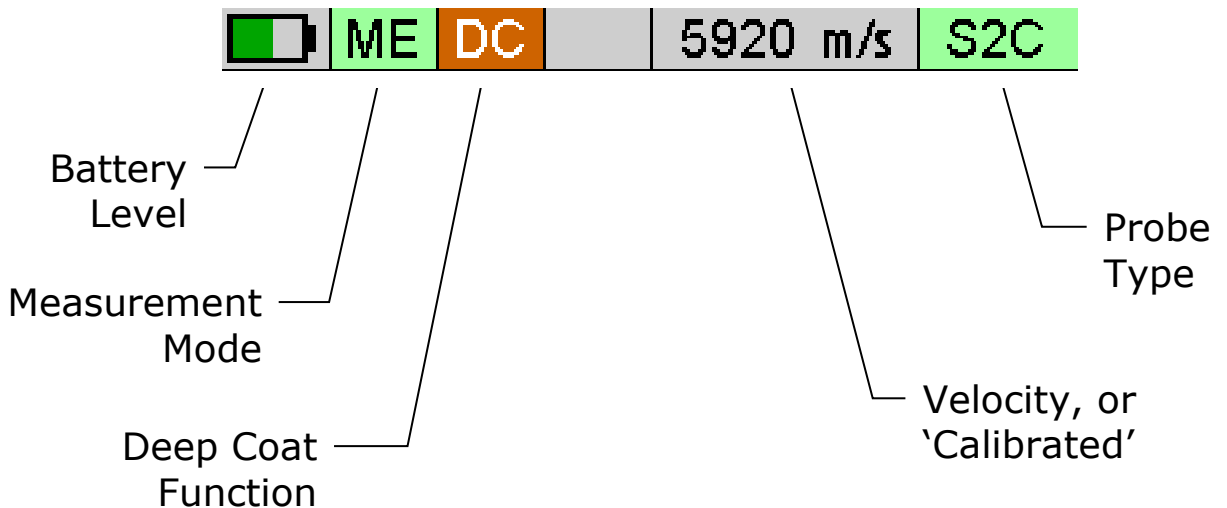



Probe Type; when the probe is connected the background colour is green, when disconnected it is grey.

Measurement Modes;

- ME Multiple Echo
- EE Echo-echo
- SE Single Echo

End Display for Measurements

The end display can show thickness measurements, so the gauge can be worn with a neck strap or in a pocket.

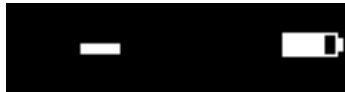
When a measurement is not yet stable, the numbers are hollow.	
Stable measurements, and multiple-echo measurements are shown in solid numbers.	
When no measurement is available, the battery level is shown.	

Taking Thickness Measurements

Taking ultrasonic thickness measurements is a straightforward process that involves first making sure the surface is clean and prepared, applying an ultrasonic couplant gel then placing the probe on the surface and observing the display for the measurement.

Zeroing the Probe (twin element probes)

When a twin element probe is connected to the gauge (and the gauge is set to the correct probe) you must first perform a **Probe Zero** before you can begin taking measurements. For instructions see Probe Zero Function on page 50.



It is recommended to frequently perform a Probe Zero especially if conditions such as temperature are changing. At least every 30 minutes.

Taking the Thickness Measurement

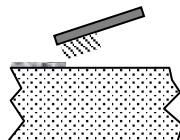
1.	Remove all scale, rust, dirt or loose coatings and brush the test area clean.	
-----------	---	---

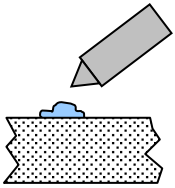
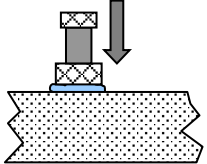
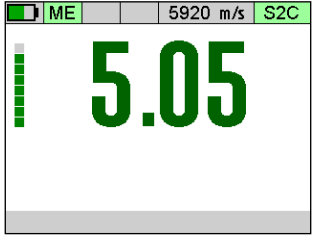
<p>2.</p>	<p>Apply ultrasonic couplant to the test surface.</p>	
<p>3.</p>	<p>Place the probe-face on the clean, lubricated test surface and make firm contact applying gentle pressure.</p>	
<p>4.</p>	<p>The gauge will display a thickness measurement. (Or an indication of Echo Strength if no valid measurement has been found in Multiple Echo mode).</p>	

Echo Indicators in Multiple Echo Mode

Should the gauge be unable to detect a stable multiple-echo signal it displays an Echo Indication to help the operator locate a suitable position.

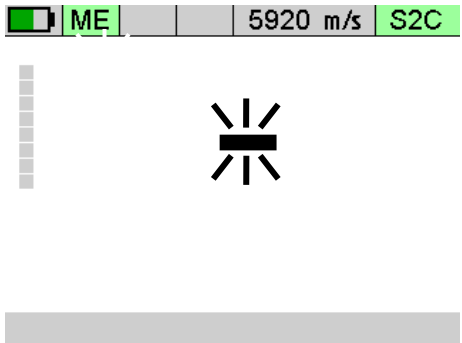
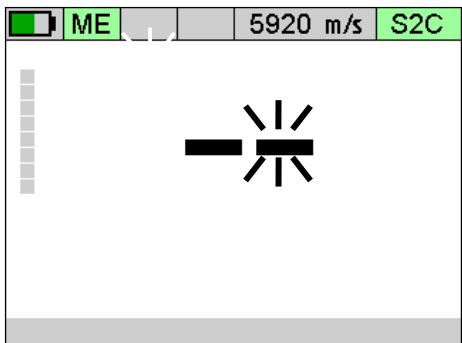
<p>1.</p>	<p>1 Bar Flashing: <i>No echoes detected</i></p>	
<p>2.</p>	<p>1 steady + 1 Bar Flashing: <i>Only 1 echo detected</i></p>	

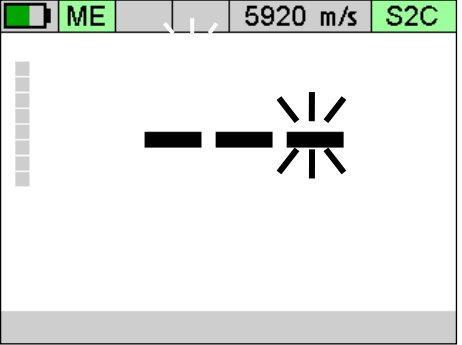
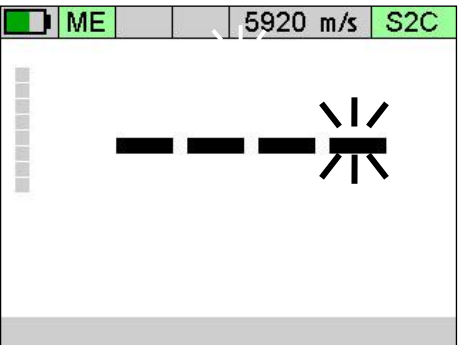
<p>3.</p>	<p>2 steady + 1 Bar Flashing: <i>Only 2 echoes detected</i></p>	 <p>The screenshot shows the top status bar with 'ME', '5920 m/s', and 'S2C'. The main display area contains a vertical scale on the left and three horizontal bars. The first two bars are solid black, and the third bar is flashing, indicated by radiating lines to its right.</p>
<p>4.</p>	<p>3 steady + 1 Bar Flashing: <i>3 echoes detected but they are not matched</i></p>	 <p>The screenshot shows the top status bar with 'ME', '5920 m/s', and 'S2C'. The main display area contains a vertical scale on the left and four horizontal bars. The first three bars are solid black, and the fourth bar is flashing, indicated by radiating lines to its right.</p>

To help obtain a multiple echo reading the operator should continue to move the probe around to locate a suitable reflector, using a slight rocking motion.

Measurement Stability Indication in SE & EE Modes

To help indicate when a Single Echo or Echo-Echo measurement is stable – and thus probably reliable – the gauge changes the thickness measurement number colour from Red to Green when the measurement has been stable for 2 consecutive seconds.

When measuring using Single Echo or Echo-Echo mode once you have a measurement keep the probe still and wait for the gauge to signal a “stable reading”.

If the ultrasound signal is poor or erratic then the thickness value may remain red – thus indicating the measurement may not be reliable.

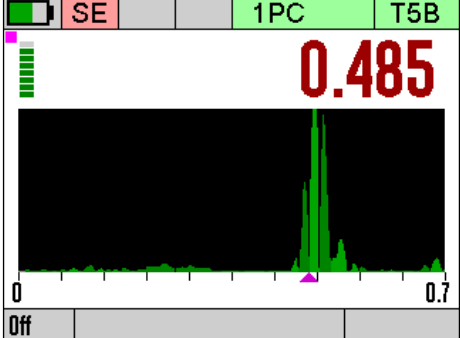
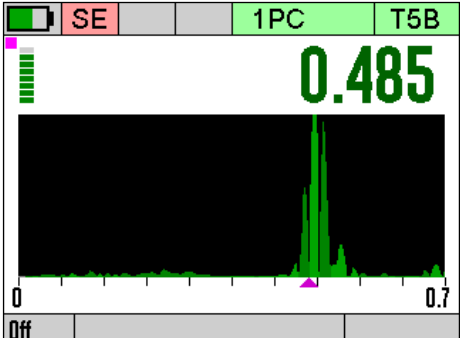
<p>1. Initial measurements will be displayed as red numbers.</p>		
<p>2. If the measurement remains stable for 2 consecutive seconds then the measurement will change to green.</p>		

Stable is defined as; the thickness measurement changing no more than + or - the Resolution setting.

Example.

The Resolution is set to 0.05mm, therefore the thickness measurement must not change by more than +0.05mm or -0.05mm for 2 seconds or more to be "stable".

The Resolution is set to 0.002", therefore the thickness measurement must not change by more than +0.002" or -0.002" for 2 seconds or more to be "stable".

Measuring Small Diameter Pipe & Tubes

When measuring small diameter pipe and tubes with a twin element probe, 75mm (3") or under, you must ensure the face of the probe is correctly aligned to the curvature of the pipe otherwise measurements may be inaccurate.



The dividing line on the face of the probe should be at right angles to the length of the pipe.

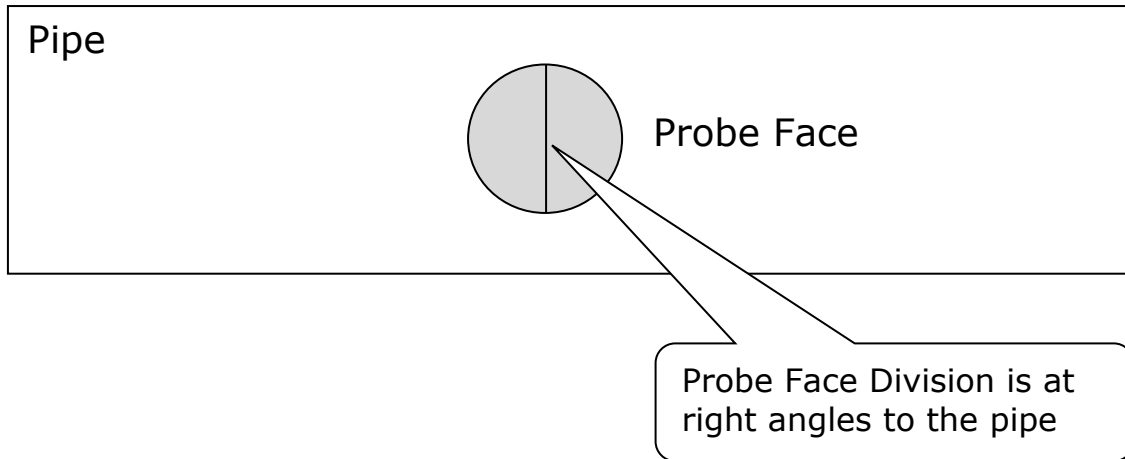

Display Hold Feature

The thickness measurement can be 'Held' or frozen by pressing the **X** key while in any measurement screen.

<p>1.</p>	<p>A thickness measurement is displayed</p>	
<p>2.</p>	<p>Press the X key to hold the thickness measurement.</p> <p>The measurement value now has a light blue border to indicate it's held or froze.</p>	
<p>3.</p>	<p>Press the X key to un-hold the thickness measurement.</p>	



Battery Life

The gauge will operate for approximately 10 hrs when fitted with Duracell Alkaline 1500 mA/hr batteries.

Battery Level

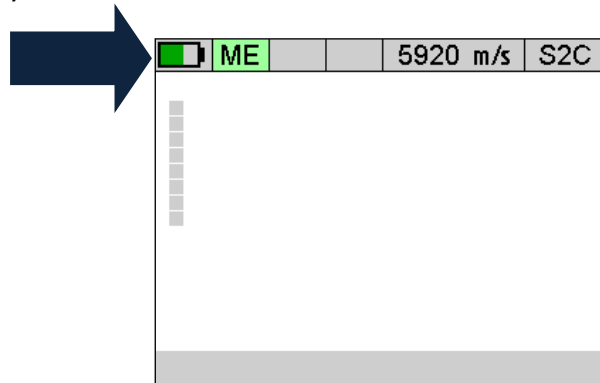
A battery level graphic is displayed at the top left position of the display (arrowed);



Battery almost full	
Battery about 1/2 full	
Battery low	

Low Battery Indication

The gauge will periodically flash a red Low Battery warning sign when the batteries have approximately 1 hour of use remaining.

Low battery indication	
------------------------	--

When the batteries are exhausted the gauge will display a **Flat Battery** message for 5 seconds then turn off automatically.

Flat Battery message	
----------------------	--

7. Using the A-Scan Display

To help ensure reliable measurements in Single Echo and Echo-Echo measurements the gauge has an A-Scan display that can be used to visually verify the thickness measurements are sensible and therefore reliable. With some practice any user can quickly and easily use the A-Scan to decide if the measurement is correct.

To view the A-Scan display use the Left and Right navigation keys to switch between the measurement screen views (see Measurement Screen Views on page 29).

The A-Scan display shows the actual ultrasound echo pulses as received by the gauge; these echo pulses are used by the gauge to determine the thickness measurement if possible.

The gauge works by generating a short pulse of ultrasound that is coupled into the object you are measuring. This pulse then travels through the object and is reflected back to the probe as an echo by either the back-wall of the object and/or any internal flaws or corrosion pits. When the echo pulse hits the probe surface a signal is received by the gauge, this signal is shown on the A-scan display as an echo peak, the taller the peak the stronger the signal.

Single Echo Mode

The A-Scan display is very useful when measuring in Single Echo modes, as there is no verification of the thickness measurement observing the A-Scan display will help the user verify the echo detected is the correct one – the back-wall echo.

This A-Scan shows a good clear ultrasound signal.

There is a well-defined back-wall echo and the arrow is correctly placed.

The measurement value of 12.7 mm is stable when green in colour.

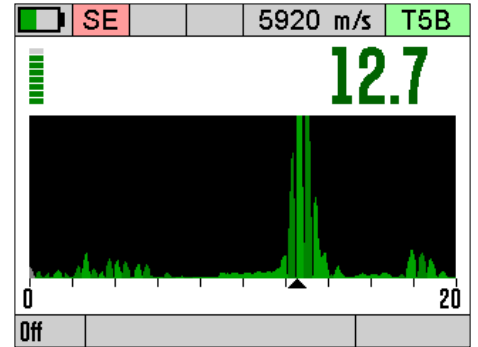

Good Signal

This A-Scan shows a very weak ultrasound signal.

There is no clear correct back-wall echo and the gauge is unable to determine a thickness measurement.

You should try moving the probe to find a better reflector, first rotate the probe to see if that gets a measurement, if that fails then try another position.

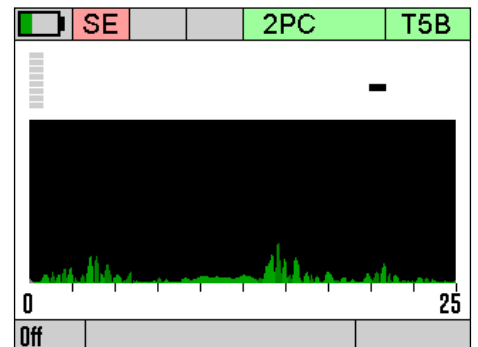

Weak Signal

Measuring Over Corrosion Pits



You should be careful not to attempt to take a single echo thickness measurement when there is a void or corrosion pit directly underneath the probe face as the gauge will incorrectly measure the depth of the couplant.



Large Corrosion Pits.

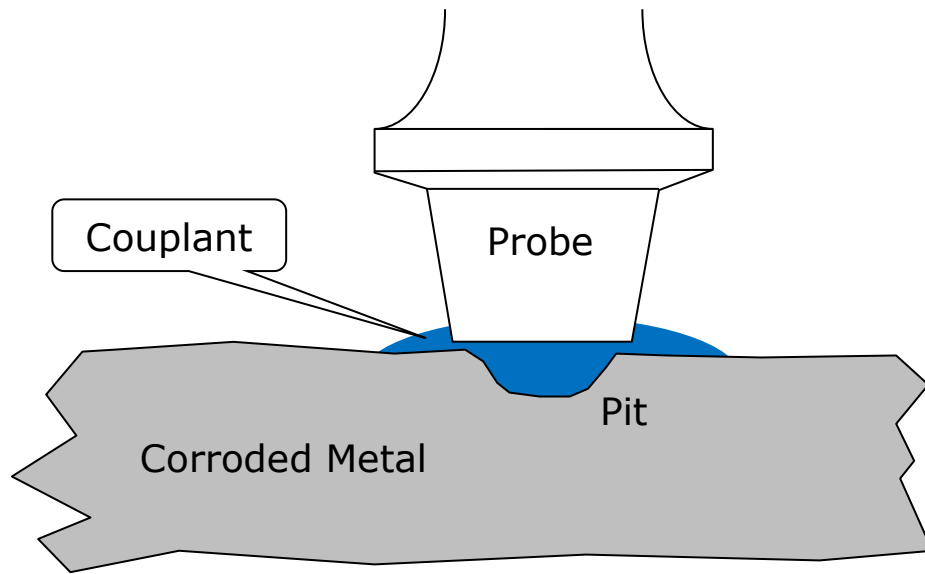

Avoid Measuring Directly Over Corrosion Pits.

The A-Scan display can assist you - you will see an unclear ultrasound signal with unclear back wall reflections.

This A-Scan shows an incorrect measurement that may be from measuring couplant inside a pit.

SE
5920 m/s
T5B

3.3

0
40

Off

Echo-Echo Mode

Like Single Echo mode the A-Scan can be very useful when taking measurement through coating using Echo-Echo mode. Echo-Echo mode measures thickness by measuring the time between two consecutive echo signals, in ideal conditions this is a good reliable method of thickness measurement thorough coating, but when corrosion starts to degrade the echoes the gauge could measure between two incorrect echoes and give a wrong reading. Here the A-Scan can assist, by observing the echo signals you can decide of the thickness measurement given makes sense and is reliable.

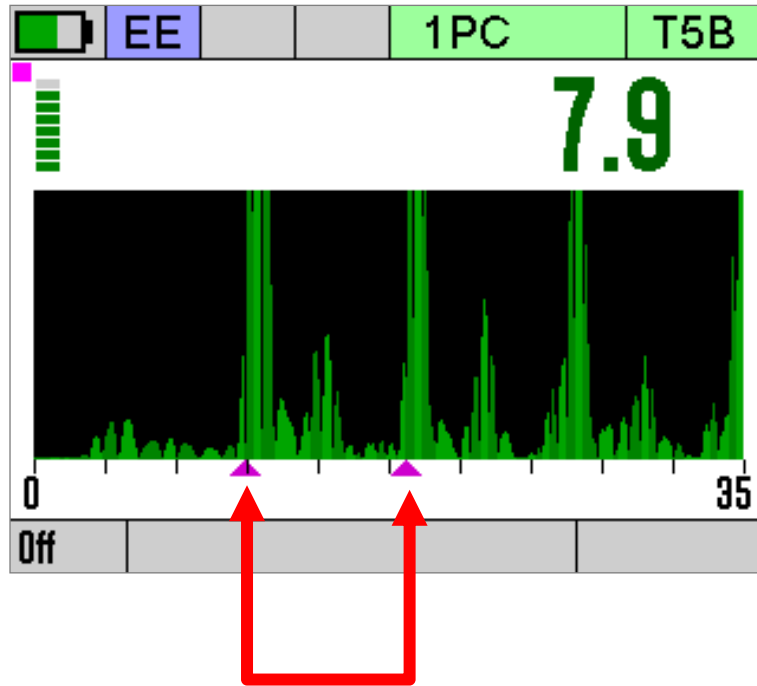

The gauge measures between these two echo signals to calculate the thickness. This is a good clear signal so the measurement is reliable.

The two purple arrows mark the points the gauge has measured between.

This A-Scan shows an unclear Echo-Echo measurement.

The echoes are scattered and although the gauge has given a thickness measurement of 5.2mm it may not be accurate. Try first rotating the probe then another location.

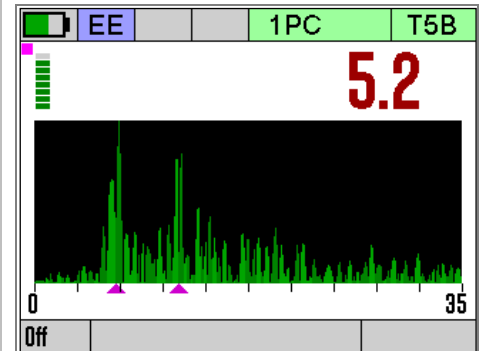

Multiple Echo Mode

Although Multiple Echo mode has the benefit of providing “echo matched” verified thickness measurements and can be used reliably without observing the A-Scan display, the A-Scan display can sometimes help where measurements are difficult or suspect.

This A-Scan shows a good Multiple-Echo measurement on a new steel sample.

The echo signals are distinct and clear. The three purple arrows mark the positions the gauge used for the thickness measurement.

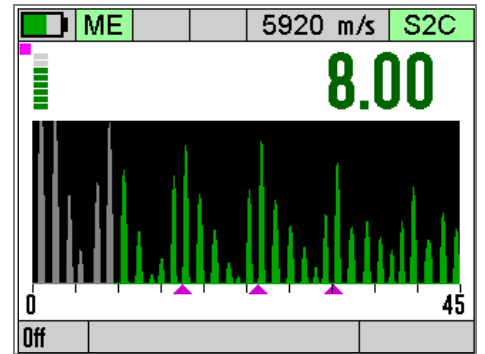

This A-Scan shows a Multiple-Echo measurement from a corroded steel sample.

The three echo signals have been picked out ok, but there is less clarity around echo 2 and 3.

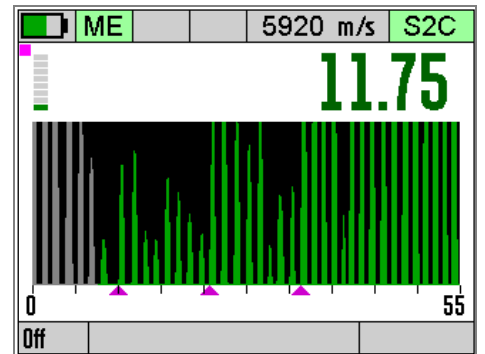

This A-Scan shows no Multiple-Echo measurement.

The echo signals are all over the display, there are no distinct echoes for the gauge to pick out. You should move the probe to another location or try using SE or EE mode.

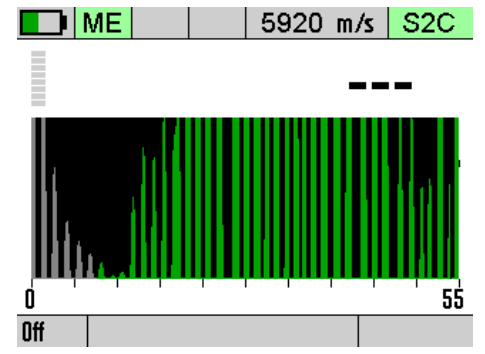

8. Calibration

Why should I Calibrate my Thickness Gauge?

Ultrasonic thickness gauges measure time in order to measure the thickness of the material being tested. It relies on the principal that sound travels through a material at a constant velocity or speed. If you can accurately measure the time it takes to travel through a material and you know its velocity then you can calculate its thickness;

$$\text{Thickness} = \frac{\text{time} \times \text{velocity}}{2}$$

Modern thickness gauge are easily capable of measuring **time** accurately to 10 Nano seconds (0.000,000,01 seconds) so this is considered to be more than sufficiently accurate.

This means the accuracy of any thickness gauge measurement relies principally on the **velocity** being correct for the material being measured.

There are tables listing the velocity of most common metals and materials, but these velocities are only "typical" values. For example Mild Steel has a typical velocity of 5920 m/s – but in practice when measuring a variety of mild steel samples the velocity can range anywhere from 5860 to 5980 m/s.

This means if you want to achieve the most accurate thickness measurements you must calibrate your thickness gauge to a sample of the same material you will be testing – and a sample that you can accurately measure the thickness of with a Vernier or micrometer.

Your measurements are only as good as your calibration

Instructions for calibrating the gauge can be found on page 44 onwards.

Calibration Options

The Gauge is supplied tested and calibrated. The Gauge will have been calibrated to measure thickness through steel (grade S355JO) with a velocity of sound of 5920 m/s.

Either a 15mm or 1/2" **Test Block** is supplied with the kit so the Gauge can be quickly checked for correct operation. Note, this test block is not intended to be used for calibration of the Gauge.

 The best way to calibrate the Gauge is to Calibrate using a Known Thickness using a sample of the material you intend to measure. This method determines the velocity of sound for the material sample, which will always be more accurate than using a 'general' velocity value. For calibration instructions see page 44.

If there is no test sample available the Gauge can be calibrated by [Setting the Velocity of Sound](#) directly. A [table](#) on page 161 at the back of this manual lists common materials and their velocity of sound value. For calibration instructions see page 45.







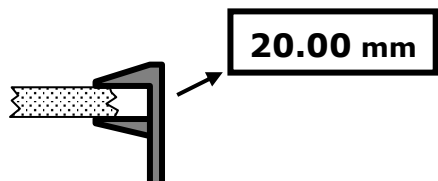

A third method is to leave the Gauge set to its factory-pre-set value for Steel [5920 m/s or 0.2332 in/us], and then use a Conversion Factor from the [table of velocities](#) on page 161.

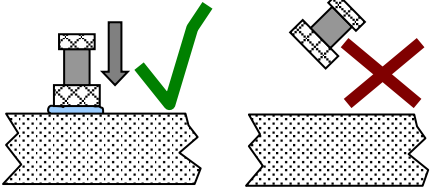
Calibrating to a known thickness (Single or 1 Point)

This method of calibrating the gauge is more accurate than using a standard velocity value as the gauge calculates the velocity of sound for the sample material.

You can use this calibration method for all measurement modes.

<p>1.</p>	<p>Accurately measure the thickness of your sample material.</p>	
------------------	--	--

<p>2.</p>	<p>Place the Probe on the sample and verify the gauge can get a thickness value.</p>																						
<p>3.</p>	<p>Access the Menu and scroll down to the 'Calibration' group. Then scroll right to the '1 Point Cal' item.</p> <p>Press the ✓ key to open the '1 Point Cal' function</p>	<table border="1" style="width: 100%; border-collapse: collapse;"> <tr> <td colspan="2" style="text-align: right;">Main Menu</td> <td style="text-align: right;">11:02:06</td> </tr> <tr> <td>Data Logging</td> <td style="background-color: #0056b3; color: white;">1 Point Cal</td> <td></td> </tr> <tr> <td>Measurement</td> <td>Velocity</td> <td style="text-align: right;">5920</td> </tr> <tr> <td>Limits</td> <td>Material</td> <td></td> </tr> <tr> <td>Probe</td> <td></td> <td></td> </tr> <tr> <td style="background-color: #0056b3; color: white;">Calibration</td> <td></td> <td></td> </tr> <tr> <td>Setup</td> <td></td> <td></td> </tr> </table> <p style="background-color: #cccccc; padding: 5px;">Perform a calibration on a material sample of known thickness.</p>	Main Menu		11:02:06	Data Logging	1 Point Cal		Measurement	Velocity	5920	Limits	Material		Probe			Calibration			Setup		
Main Menu		11:02:06																					
Data Logging	1 Point Cal																						
Measurement	Velocity	5920																					
Limits	Material																						
Probe																							
Calibration																							
Setup																							
<p>4.</p>	<p>While holding the probe firmly on the sample and while a steady thickness measurement is displayed..</p>	<table border="1" style="width: 100%; border-collapse: collapse;"> <tr> <td style="text-align: center;">Calibration 1 Point</td> <td style="text-align: right; background-color: #90ee90;">S2C</td> </tr> <tr> <td style="text-align: center;">  20.00 </td> <td></td> </tr> <tr> <td colspan="2" style="text-align: center;"> <p>Velocity :5925</p> <p>Use the UP and DOWN keys to adjust the thickness measurement to the correct value Press ✓ to save X to cancel</p> </td> </tr> </table>	Calibration 1 Point	S2C	 20.00		<p>Velocity :5925</p> <p>Use the UP and DOWN keys to adjust the thickness measurement to the correct value Press ✓ to save X to cancel</p>																
Calibration 1 Point	S2C																						
 20.00																							
<p>Velocity :5925</p> <p>Use the UP and DOWN keys to adjust the thickness measurement to the correct value Press ✓ to save X to cancel</p>																							
<p>5.</p>	<p>...use the Up and Down keys to adjust the thickness to the required value.</p>																						
<p>6.</p>	<p>When done press the ✓ key to save the calibration. A Calibration Saved message will be shown.</p> <p>Or press the X key to exit without saving the calibration.</p>	<table border="1" style="width: 100%; border-collapse: collapse;"> <tr> <td style="text-align: center;">Calibration 1 Point</td> <td style="text-align: right; background-color: #90ee90;">S2C</td> </tr> <tr> <td style="text-align: center;">  20.00 </td> <td></td> </tr> <tr> <td colspan="2" style="text-align: center;"> <div style="background-color: yellow; border: 2px solid black; padding: 5px; display: inline-block;"> <p>Calibration Saved</p> </div> </td> </tr> <tr> <td colspan="2" style="text-align: center;"> <p>Use the UP and DOWN keys to adjust the thickness measurement to the correct value Press ✓ to save X to cancel</p> </td> </tr> </table>	Calibration 1 Point	S2C	 20.00		<div style="background-color: yellow; border: 2px solid black; padding: 5px; display: inline-block;"> <p>Calibration Saved</p> </div>		<p>Use the UP and DOWN keys to adjust the thickness measurement to the correct value Press ✓ to save X to cancel</p>														
Calibration 1 Point	S2C																						
 20.00																							
<div style="background-color: yellow; border: 2px solid black; padding: 5px; display: inline-block;"> <p>Calibration Saved</p> </div>																							
<p>Use the UP and DOWN keys to adjust the thickness measurement to the correct value Press ✓ to save X to cancel</p>																							

When a Calibration has been made a '1PC' indicator is displayed at the top of the measurement screen in the status area (1PC = Single Point Calibration).



'1PC' Indicator

Two Point Calibration

The Two Point Calibration option is only available in Single Echo and Echo-Echo modes.

Two point calibration allows the gauge to be calibrated against two reference thicknesses of the same material, one at the minimum (thin) thickness range the other at the maximum (thick) thickness range.

! **To achieve maximum accuracy in Single Echo mode you must perform a Two Point Calibration – your measurement is only as good as your calibration.**

When performing a two point calibration both sample thicknesses should be made from the same material. The temperature of the sample material should be the close to the temperature of the material to be measured.

The gauge will automatically compensate for v-path error in addition to either single or two point calibrations.



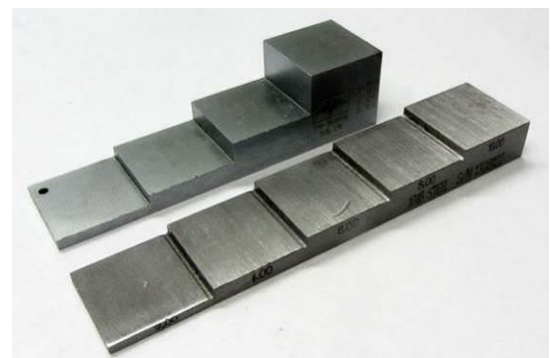

Ladder Step Wedge



Typically a Ladder Step Wedge is used to calibrate the probe and gauge for Steel. The ladder step wedge has 4 or 5 different thicknesses typically ranging from 2.5 to 20.0 mm (0.1 to 0.5"). You would typically choose to calibrate using the 2.5 and 20 mm thicknesses.



Ladder Step Wedges

Two Point Calibration Procedure

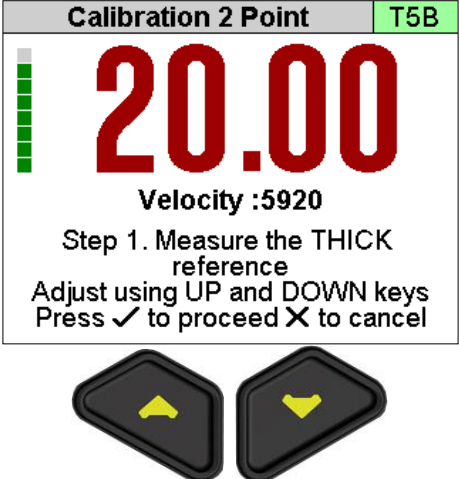
<p>1.</p>	<p>Assuming you have a step wedge of known thicknesses</p>																									
<p>2.</p>	<p>Wipe clean the step wedge then add some fresh couplant to the step wedge</p>																									
<p>3.</p>	<p>Place the Probe on the sample and verify the gauge can get a thickness value.</p>																									
<p>4.</p>	<p>Access the Menu and scroll down to the 'Calibration' group. Then scroll right to the '2 Point Cal' item.</p> <p>Press the \checkmark key to open the '2 Point Cal' screen</p>	<table border="1"> <tr> <td colspan="2">Main Menu</td> <td>12:32:55</td> </tr> <tr> <td>Data Logging</td> <td>1 Point Cal</td> <td></td> </tr> <tr> <td>Measurement</td> <td>2 Point Cal</td> <td></td> </tr> <tr> <td>Limits</td> <td>Velocity</td> <td>5920</td> </tr> <tr> <td>Probe</td> <td>Material</td> <td></td> </tr> <tr> <td>Calibration</td> <td></td> <td></td> </tr> <tr> <td>Setup</td> <td></td> <td></td> </tr> <tr> <td colspan="3">Perform a Minimum and Maximum 2 point calibration on a sample of known thickness.</td> </tr> </table>	Main Menu		12:32:55	Data Logging	1 Point Cal		Measurement	2 Point Cal		Limits	Velocity	5920	Probe	Material		Calibration			Setup			Perform a Minimum and Maximum 2 point calibration on a sample of known thickness.		
Main Menu		12:32:55																								
Data Logging	1 Point Cal																									
Measurement	2 Point Cal																									
Limits	Velocity	5920																								
Probe	Material																									
Calibration																										
Setup																										
Perform a Minimum and Maximum 2 point calibration on a sample of known thickness.																										
<p>5.</p>	<p>Start with the Thick sample - Maximum thickness.</p>																									

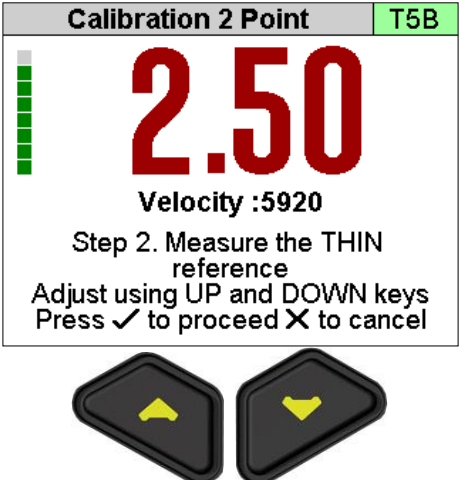
<p>6.</p>	<p>While holding the probe firmly on the thick sample and while a steady thickness measurement is displayed..</p> <p>...use the Up and Down Select keys to adjust the thickness to the required value.</p>	
<p>7.</p>	<p>When the correct measurement is displayed press the ✓ key</p>	
<p>8.</p>	<p>Next measure the Thin sample – Minimum thickness.</p>	
<p>9.</p>	<p>While holding the probe firmly on the thin sample and while a steady thickness measurement is displayed..</p> <p>...use the Up and Down Select keys to adjust the thickness to the required value.</p>	
<p>10.</p>	<p>When the correct measurement is displayed press the ✓ key</p>	

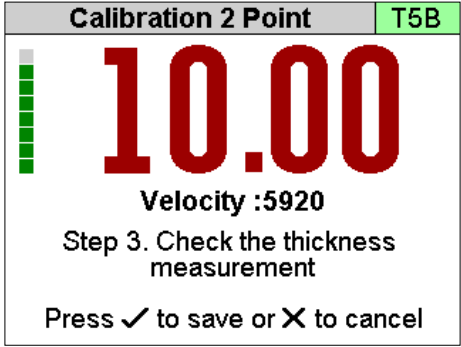
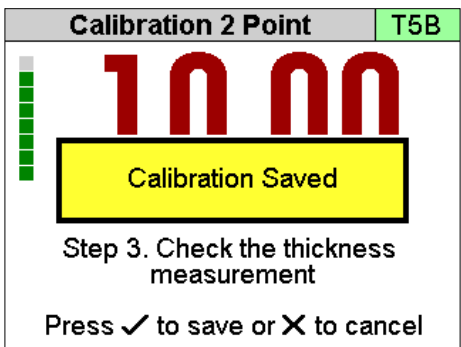
<p>11.</p>	<p>The 3rd screen lets you check the calibration is correct by checking a few different measurements on the step wedge.</p>	
<p>12.</p>	<p>When done press the ✓ key to save the calibration. A Calibration Saved message will be shown.</p> <p>Or press the ✗ key to exit without saving the calibration.</p>	

Probe Zero (twin element probes)

Twin element probes must be zeroed to compensate for any wear or operating temperature changes. The gauge will always perform a Probe Zero when first turned on or when a twin element probe is connected.

If the probe gets significantly warmer during use this can cause a shift in the zero position and thus introduce small errors in the thickness measurement. Typically a 20°C (68°F) change in temperature the measurements can shift by 0.1 mm (0.04”).

! **It is recommended to frequently perform a Probe Zero especially if conditions such as temperature are changing.**

See also Zeroing the Probe (twin element probes) on page 31.

Starting a Probe Zero from the Main Menu

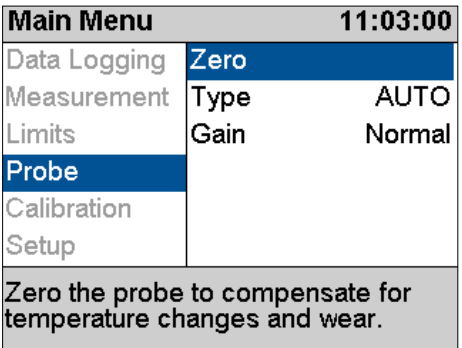
<p>1. Access the Menu and scroll down to the 'Probe' group. Then scroll right to the 'Zero' item.</p> <p>Press the \checkmark key to start the 'Zero' process</p>		 <p>Main Menu 11:03:00</p> <p>Data Logging Zero</p> <p>Measurement Type AUTO</p> <p>Limits Gain Normal</p> <p>Probe</p> <p>Calibration</p> <p>Setup</p> <p>Zero the probe to compensate for temperature changes and wear.</p>
---	--	---

Probe Zero

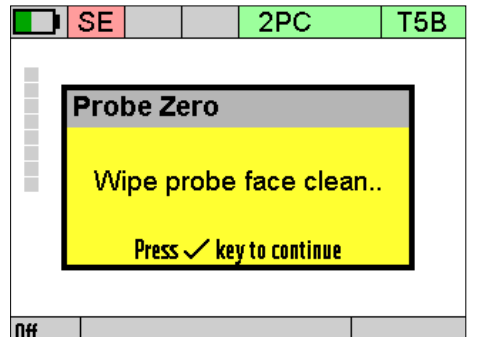
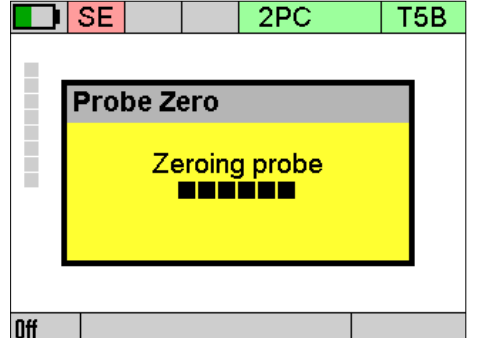
<p>2. Display shows the Zero Probe message.</p> <p>Important - Wipe any couplant from the probe face</p>		
<p>3. Press the \checkmark key to proceed</p> <p>The gauge measures the probe zero point...</p> <p>..this takes about 2 seconds.</p>		

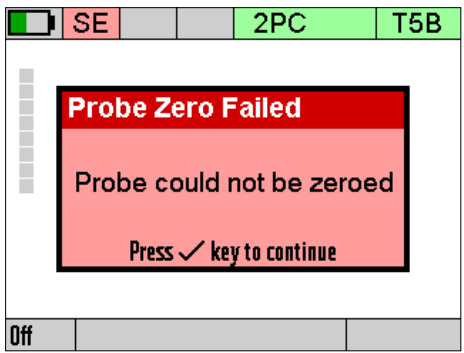
<p>4. If the Probe Zero fails a message will be displayed.</p> <ul style="list-style-type: none"> • Check the probe has not been unplugged or the cable is damaged/faulty. • The probe face must be clean and in the air. • Are you using a non-Cygnus probe? <p>You must un-plug the probe, then plug it back in to re-try the Probe Zero process.</p>	
---	--

Setting the Velocity of Sound

The gauge uses the Velocity of Sound value to calculate the material thickness value. It is therefore important the velocity value is set correctly for the material being measured.

-  If you perform a Calibration the Velocity of Sound will be set for you during the calibration – so you don't need to adjust it afterwards.

You can manually set the velocity of sound value if required; normally you would do this if;

- You can't perform a calibration
- You want to use the same velocity setting as last time
- You want to use a velocity from a material list

A list of velocity of sound values for common material can be found on page 161.

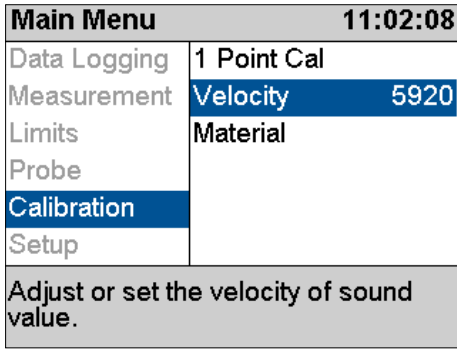
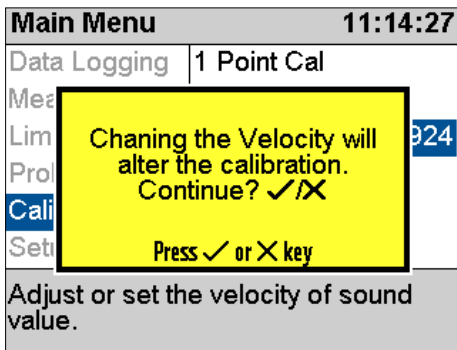
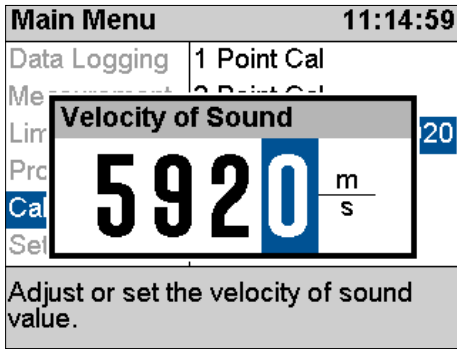
<p>1.</p>	<p>Access the Menu and scroll down to the 'Calibration' group. Then scroll right and select 'Velocity'.</p> <p>Press the \checkmark key to open the 'Velocity' screen</p>	
<p>2.</p>	<p>If there has been a previous Calibration a message will warn that changing the velocity will alter the calibration;</p> <p>Press the \checkmark key to continue, or X to abort.</p>	
<p>3.</p>	<p>Use the Up and Down keys to adjust the velocity value as required</p> <p>Use the Left and Right keys to highlight the digit to change.</p>	
<p>4.</p>	<p>When done press the \checkmark key to save the changes.</p> <p>Or press the X key to exit without saving.</p>	



When the velocity has been manually set the value is displayed at the top of the measurement screen in the status area.







Velocity of Sound value '5920 m/s'

9. Gauge Setup

Menu Operation

<p>1.</p>	<p>Press the Menu key,</p>																									
<p>2.</p>	<p>the Main Menu is displayed</p>	<table border="1"> <tr> <td colspan="2">Main Menu</td> <td style="text-align: right;">16:09:21</td> </tr> <tr> <td>Data Logging</td> <td>Resume</td> <td></td> </tr> <tr> <td>Measurement</td> <td>Review</td> <td></td> </tr> <tr> <td>Limits</td> <td>New</td> <td></td> </tr> <tr> <td>Probe</td> <td>Delete</td> <td></td> </tr> <tr> <td>Calibration</td> <td>Protect</td> <td></td> </tr> <tr> <td>Scan</td> <td>Delete All</td> <td></td> </tr> <tr> <td colspan="3">Data Logging; start and stop, add comments, new record.</td> </tr> </table>	Main Menu		16:09:21	Data Logging	Resume		Measurement	Review		Limits	New		Probe	Delete		Calibration	Protect		Scan	Delete All		Data Logging; start and stop, add comments, new record.		
Main Menu		16:09:21																								
Data Logging	Resume																									
Measurement	Review																									
Limits	New																									
Probe	Delete																									
Calibration	Protect																									
Scan	Delete All																									
Data Logging; start and stop, add comments, new record.																										
<p>3.</p>	<p>Use the four Navigation keys to scroll around the Main Menu</p>																									
<p>4.</p>	<p>Use the Up and Down keys to select a group in the left column.</p>	<table border="1"> <tr> <td colspan="2">Main Menu</td> <td style="text-align: right;">11:00:49</td> </tr> <tr> <td>Data Logging</td> <td>Limits</td> <td style="text-align: right;">Off</td> </tr> <tr> <td>Measurement</td> <td>Minimum</td> <td style="text-align: right;">0.00</td> </tr> <tr> <td>Limits</td> <td>Reference</td> <td style="text-align: right;">0.00</td> </tr> <tr> <td>Probe</td> <td>Maximum</td> <td style="text-align: right;">250.00</td> </tr> <tr> <td>Calibration</td> <td>Vibrate</td> <td style="text-align: right;">Off</td> </tr> <tr> <td>Setup</td> <td></td> <td></td> </tr> <tr> <td colspan="3">Limits, reference, minimum and maximum thickness values with alarm option.</td> </tr> </table>	Main Menu		11:00:49	Data Logging	Limits	Off	Measurement	Minimum	0.00	Limits	Reference	0.00	Probe	Maximum	250.00	Calibration	Vibrate	Off	Setup			Limits, reference, minimum and maximum thickness values with alarm option.		
Main Menu		11:00:49																								
Data Logging	Limits	Off																								
Measurement	Minimum	0.00																								
Limits	Reference	0.00																								
Probe	Maximum	250.00																								
Calibration	Vibrate	Off																								
Setup																										
Limits, reference, minimum and maximum thickness values with alarm option.																										
<p>5.</p>	<p>Press the Right key to move to the items in that group in the right column.</p> <p>Then use the Up and Down keys to select from the right column</p>	<table border="1"> <tr> <td colspan="2">Main Menu</td> <td style="text-align: right;">11:00:51</td> </tr> <tr> <td>Data Logging</td> <td>Limits</td> <td style="text-align: right;">Off</td> </tr> <tr> <td>Measurement</td> <td>Minimum</td> <td style="text-align: right;">0.00</td> </tr> <tr> <td>Limits</td> <td>Reference</td> <td style="text-align: right;">0.00</td> </tr> <tr> <td>Probe</td> <td>Maximum</td> <td style="text-align: right;">250.00</td> </tr> <tr> <td>Calibration</td> <td>Vibrate</td> <td style="text-align: right;">Off</td> </tr> <tr> <td>Setup</td> <td></td> <td></td> </tr> <tr> <td colspan="3">Turn Limits On or Off</td> </tr> </table>	Main Menu		11:00:51	Data Logging	Limits	Off	Measurement	Minimum	0.00	Limits	Reference	0.00	Probe	Maximum	250.00	Calibration	Vibrate	Off	Setup			Turn Limits On or Off		
Main Menu		11:00:51																								
Data Logging	Limits	Off																								
Measurement	Minimum	0.00																								
Limits	Reference	0.00																								
Probe	Maximum	250.00																								
Calibration	Vibrate	Off																								
Setup																										
Turn Limits On or Off																										

<p>6.</p>	<p>If you want to change or select the item currently displayed press the green ✓ button</p>																									
<p>7.</p>	<p>Then use the Navigation keys to highlight the required setting or option</p>	<table border="1"> <tr> <td colspan="2">Main Menu</td> <td>11:13:27</td> </tr> <tr> <td>Data Logging</td> <td>Limits</td> <td>On</td> </tr> <tr> <td>Measurement</td> <td>Minimum</td> <td>5.0</td> </tr> <tr> <td>Limits</td> <td>Enable Limits</td> <td>10.0</td> </tr> <tr> <td>Probe</td> <td>Off</td> <td>20.0</td> </tr> <tr> <td>Calibr</td> <td>On</td> <td>On</td> </tr> <tr> <td>Setup</td> <td></td> <td></td> </tr> <tr> <td colspan="3">Turn Limits On or Off</td> </tr> </table>	Main Menu		11:13:27	Data Logging	Limits	On	Measurement	Minimum	5.0	Limits	Enable Limits	10.0	Probe	Off	20.0	Calibr	On	On	Setup			Turn Limits On or Off		
Main Menu		11:13:27																								
Data Logging	Limits	On																								
Measurement	Minimum	5.0																								
Limits	Enable Limits	10.0																								
Probe	Off	20.0																								
Calibr	On	On																								
Setup																										
Turn Limits On or Off																										
<p>8.</p>	<p>Press the green ✓ key to save your choice</p>																									
<p>9.</p>	<p>Or press the red X key to abort</p>																									
<p>10.</p>	<p>Press the Left key to go back to the main group if you want to make another selection</p>	<table border="1"> <tr> <td colspan="2">Main Menu</td> <td>11:00:49</td> </tr> <tr> <td>Data Logging</td> <td>Limits</td> <td>Off</td> </tr> <tr> <td>Measurement</td> <td>Minimum</td> <td>0.00</td> </tr> <tr> <td>Limits</td> <td>Reference</td> <td>0.00</td> </tr> <tr> <td>Probe</td> <td>Maximum</td> <td>250.00</td> </tr> <tr> <td>Calibration</td> <td>Vibrate</td> <td>Off</td> </tr> <tr> <td>Setup</td> <td></td> <td></td> </tr> <tr> <td colspan="3">Limits, reference, minimum and maximum thickness values with alarm option.</td> </tr> </table>	Main Menu		11:00:49	Data Logging	Limits	Off	Measurement	Minimum	0.00	Limits	Reference	0.00	Probe	Maximum	250.00	Calibration	Vibrate	Off	Setup			Limits, reference, minimum and maximum thickness values with alarm option.		
Main Menu		11:00:49																								
Data Logging	Limits	Off																								
Measurement	Minimum	0.00																								
Limits	Reference	0.00																								
Probe	Maximum	250.00																								
Calibration	Vibrate	Off																								
Setup																										
Limits, reference, minimum and maximum thickness values with alarm option.																										
<p>11.</p>	<p>To exit the menu press the Menu or red X key once.</p>																									





Settings are Saved with the Probe Type

Certain gauge settings are saved against the probe type. This allows each probe type to have different settings that will be recalled when that probe is re-connected and the probe type is correctly set. The following settings are saved with each probe type;

- Units
- Resolution
- Velocity of sound
- Calibration
- Deep Coat

Inputting Numeric Values using the Navigation Keys

Some menu screens require the user to input a numeric value using the navigation keys. This is done a 'digit' at a time, using the Left and Right keys to select the digit, then the Up and Down keys to change the highlighted digits value.

1.	The units digit is highlighted. Pressing Up or Down will change the units value only.	
2.	Pressing the Left key will move the highlight to the tens digit. Pressing Up or Down will change this value only.	
3.	Pressing the Left key will move the highlight to the hundreds digit. Pressing Up or Down will change this value only.	
4.	Pressing the Left key will move the highlight to the thousands digit. Pressing Up or Down will change this value only.	

Inputting Text using the Navigation Keys

Some functions may require alphanumeric text to be input into the gauge. This is done using a special alphanumeric entry screen and the navigation keys.

<p>1.</p>	<p>The screen is divided into 'virtual' keys like a QWERTY keyboard.</p> <p>You move the Blue highlight around using the 4 navigation keys.</p> <p>Then press the ✓ key to enter the character or perform the selected function.</p>	
<p>2.</p>	<p>To enter the word CYGNUS you would move the blue highlight from Ok to 'C' then press the ✓ key, then move to the 'Y'...</p>	
<p>3.</p>	<p>There are 'keys' for Delete last = Del Space = Spc Clear all = Clr Move = ◀ ▶ Toggle case = ▲</p>	
<p>4.</p>	<p>When you have entered your word just move the highlight to the green 'Ok' at the bottom and press the ✓ key.</p>	

Selecting the Probe Type



The Probe Type must be set to match the probe connected to the gauge. If the wrong probe is selected the gauge will not measure accurately if at all.

The gauge has an Automatic Probe Detection feature than can identified certain types of probes when they are first connected to the gauge, or you can manually select the probe from a list.

These probes can be Auto Detected;

T2C, T5B, T7A, T5A

These probes must be selected manually;

S2C, S3C, S5A, S5C & T5BH

Confirming the Probe Type when Connected

When a probe is connected to the gauge that can't be identified the gauge will ask the user to select the correct probe from a list on the screen. You must select a probe to continue.

Changing the Probe Type

The Probe Type is displayed is displayed at the top of the measurement screen in the status area. When a probe is connected the background is green. When no probe is detected the background is grey.



S2C Probe Selected and Connected

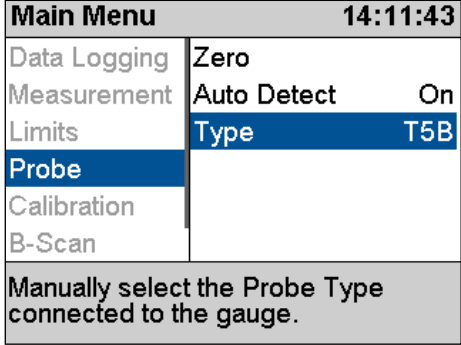
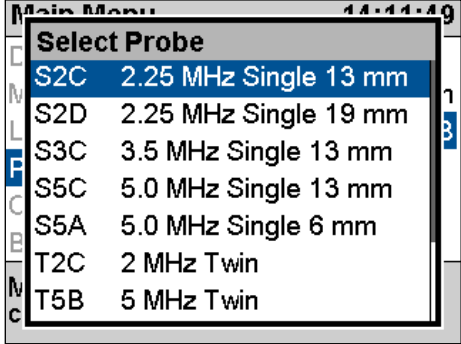

S2C Probe Selected but NOT Connected

<p>1.</p>	<p>Access the Menu and scroll down to the 'Probe' group. Then scroll right and select 'Type'.</p> <p>Press the ✓ key to open the 'Select Probe' screen</p>	 <p>Main Menu 14:11:43</p> <table border="1"> <tr> <td>Data Logging</td> <td>Zero</td> <td></td> </tr> <tr> <td>Measurement</td> <td>Auto Detect</td> <td>On</td> </tr> <tr> <td>Limits</td> <td>Type</td> <td>T5B</td> </tr> <tr> <td>Probe</td> <td></td> <td></td> </tr> <tr> <td>Calibration</td> <td></td> <td></td> </tr> <tr> <td>B-Scan</td> <td></td> <td></td> </tr> </table> <p>Manually select the Probe Type connected to the gauge.</p>	Data Logging	Zero		Measurement	Auto Detect	On	Limits	Type	T5B	Probe			Calibration			B-Scan					
Data Logging	Zero																						
Measurement	Auto Detect	On																					
Limits	Type	T5B																					
Probe																							
Calibration																							
B-Scan																							
<p>2.</p>	<p>Use the Up and Down keys to select the Probe Type required</p>	 <p>Main Menu 14:11:49</p> <p>Select Probe</p> <table border="1"> <tr> <td>S2C</td> <td>2.25 MHz Single</td> <td>13 mm</td> </tr> <tr> <td>S2D</td> <td>2.25 MHz Single</td> <td>19 mm</td> </tr> <tr> <td>S3C</td> <td>3.5 MHz Single</td> <td>13 mm</td> </tr> <tr> <td>S5C</td> <td>5.0 MHz Single</td> <td>13 mm</td> </tr> <tr> <td>S5A</td> <td>5.0 MHz Single</td> <td>6 mm</td> </tr> <tr> <td>T2C</td> <td>2 MHz Twin</td> <td></td> </tr> <tr> <td>T5B</td> <td>5 MHz Twin</td> <td></td> </tr> </table>	S2C	2.25 MHz Single	13 mm	S2D	2.25 MHz Single	19 mm	S3C	3.5 MHz Single	13 mm	S5C	5.0 MHz Single	13 mm	S5A	5.0 MHz Single	6 mm	T2C	2 MHz Twin		T5B	5 MHz Twin	
S2C	2.25 MHz Single	13 mm																					
S2D	2.25 MHz Single	19 mm																					
S3C	3.5 MHz Single	13 mm																					
S5C	5.0 MHz Single	13 mm																					
S5A	5.0 MHz Single	6 mm																					
T2C	2 MHz Twin																						
T5B	5 MHz Twin																						
<p>3.</p>	<p>Press the ✓ key to save.</p> <p>Or press the X key to exit without saving.</p>																						

 Remember settings and calibration is saved with each probe type. So if you change the probe type you may find a setting has changed – this is normal.

The reason settings are saved with each probe type is so you can swap probes during a survey without having to re-calibrate each time.

Automatic Probe Detection

The Automatic Probe Detection feature works by listening to how the probe behaves when it is first plugged in. For that reason the probe **MUST BE** in the air and not coupled to a surface when plugging in or turning on the gauge.

You can turn the automatic probe detection feature on or off from the Probe menu using the **Auto Detect** item.

When **Auto Detect** is set to **On** and a probe is connected the gauge will try and determine the probe type – this will be displayed at the top of the screen on the right.



S2C Probe Selected and Connected

Observe the probe type displayed and check it matches the probe connected to the gauge.

If the gauge fails to correctly detect the probe type then you must manually select from the list of probes. See Selecting the Probe Type on page 57.

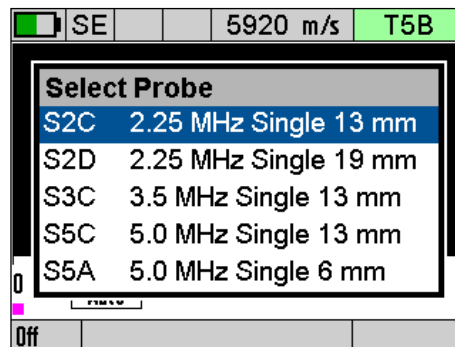

Manual Probe Selection – Single Element Probe Detected.

Measurement Units

The Gauge can display thickness measurements in either Metric (mm) or Imperial (inch). Changing the measurement units will not affect the calibration.

1. Access the Menu and scroll down to the 'Measurement' group. Then scroll right and select 'Units'.

Press the \checkmark key to open the 'Units' screen

Main Menu		11:00:41
Data Logging	Mode	ME
Measurement	Units	mm
Limits	Resolution	0.05
Probe	Deep Coat	Off
Calibration		
Setup		
Measurement units, mm or Inches.		

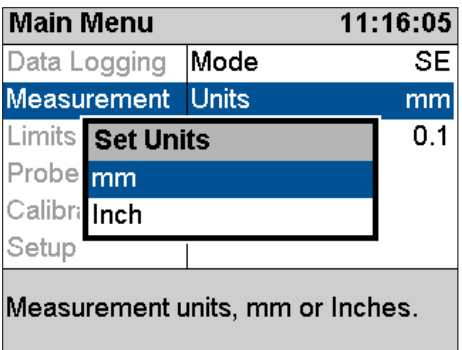
<p>2. Use the Up and Down keys to switch from mm to Inch</p>		 <p>The screenshot shows the 'Main Menu' at 11:16:05. The 'Measurement Units' menu item is selected, and a dialog box titled 'Set Units' is displayed with 'mm' and 'Inch' as options. Below the menu, a note reads: 'Measurement units, mm or Inches.'</p>
<p>3. Press the ✓ key to save. Or press the X key to exit without saving.</p>		

Resolution Setting

The gauge can display thickness measurements in three resolution settings:

- 0.1 mm 0.005 inch All Modes
- 0.05 mm 0.002 inch ME Mode only
- 0.01 mm 0.001 inch SE and EE Modes only

For general metal corrosion measurement the 0.1 mm (0.005”) Resolution setting is recommended.

To change the Resolution setting:

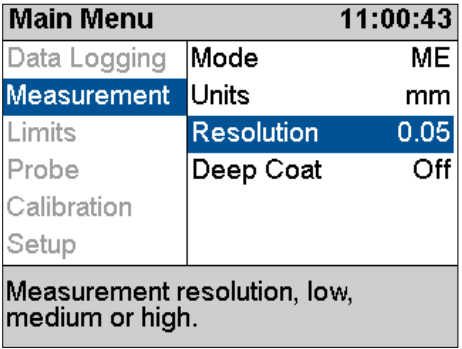
<p>1. Access the Menu and scroll down to the 'Measurement' group. Then scroll right and select 'Resolution'.</p> <p>Press the ✓ key to open the 'Resolution' screen</p>		 <p>The screenshot shows the 'Main Menu' at 11:00:43. The 'Measurement' menu item is selected, and the 'Resolution' setting is highlighted and set to 0.05. Below the menu, a note reads: 'Measurement resolution, low, medium or high.'</p>
--	--	--

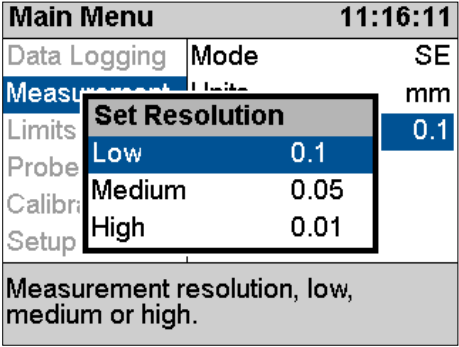
<p>2. Use the Up and Down keys to select the required Resolution</p>		
<p>3. Press the ✓ key to save. Or press the X key to exit without saving.</p>		

Limit & Alarm Feature

The gauge has a Limit feature that can be used to;

- Give visual indication of measurements between minimum, reference and maximum limits.
- Vibrate Alert the operator if measurements are outside the minimum or maximum limits

The Limit feature can be turned ON or OFF as required and the Vibrate Alert can be enabled as required.

There are three Limit measurement values you can set;

- **Minimum** Limit – this is the lowest thickness measurement, measurements under this value will cause an Alert
- **Reference** Limit – this is the 'correct' thickness value, or when corrosion monitoring this is usually set to the thickness of the steel/material when it was new.
- **Maximum** Limit – this is the highest thickness measurement, measurements over this value will cause an Alert. *This limit is optional and can be set to zero.*

When Limits are enabled the measurement screen displays a horizontal bar-graph showing the limits and the current measurement in relation to these limits. The colour of the bar also

changes from light green to dark green to red as the measurement moves from the reference value to the minimum or maximum limits.

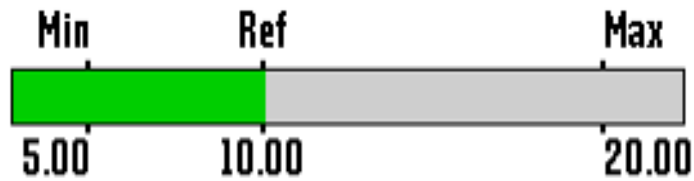

Thickness Measurement = Reference = Light Green Bar.

Limit Example

<p>Limits are setup;</p> <p>Minimum = 5.00 mm Reference = 10.00 mm Maximum = 20.00 mm</p> <p>The thickness measurement is 10.05 mm so the bar-graph shows a green bar positioned at the Reference point.</p>	
<p>Now the thickness measurement is 8.05 mm so the bar-graph shows a dark green bar positioned left of the Reference point.</p>	
<p>Now the thickness measurement is 5.10 mm so the bar-graph shows a red bar positioned at the Minimum point.</p>	

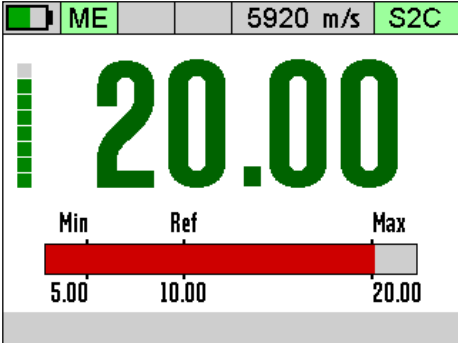
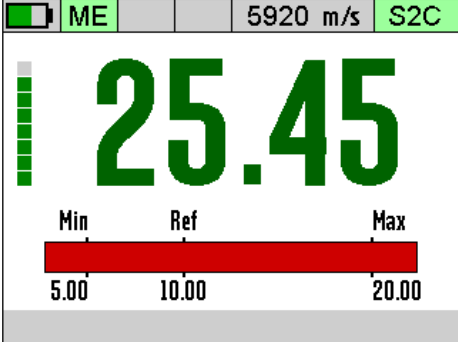
<p>Now the thickness measurement is 20.00 mm so the bar-graph shows a red bar positioned at the Maximum point.</p>	
<p>Now the thickness measurement is 25.45 mm so the bar-graph shows a red bar positioned past the Maximum point.</p> <p>This exceeds the Maximum limit so will cause a Vibrate Alert if enabled.</p>	

Setting the Limit Feature

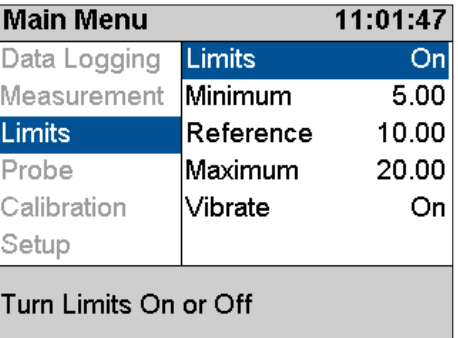
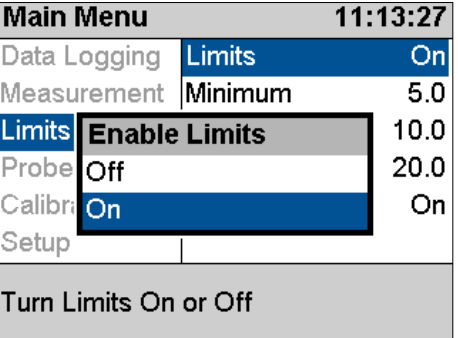
<p>1. Access the Menu and scroll down to the 'Limits' group. Then scroll right and select 'Limits'.</p> <p>Press the ✓ key to open the 'Limits' screen</p>	
<p>2. Use the Up and Down keys to turn Limits On or Off...</p> <p>Press the ✓ key to save. Or press the X key to exit without saving.</p>	

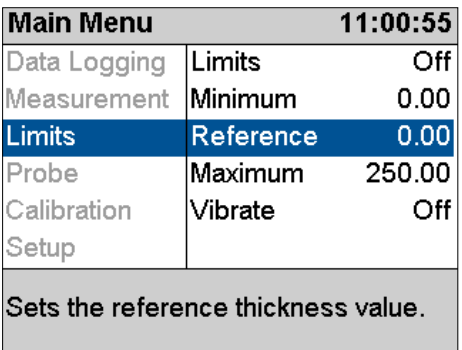
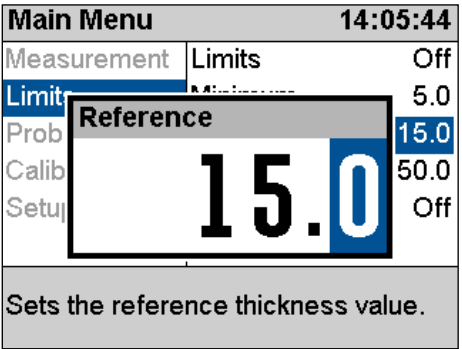
<p>3.</p>	<p>Use the Up and Down keys to select the Minimum, Reference, Maximum or Vibrate settings</p> <p>Press the ✓ key to open the selected item</p>	 <p>Main Menu 11:00:55</p> <table border="1"> <tr> <td>Data Logging</td> <td>Limits</td> <td>Off</td> </tr> <tr> <td>Measurement</td> <td>Minimum</td> <td>0.00</td> </tr> <tr> <td>Limits</td> <td>Reference</td> <td>0.00</td> </tr> <tr> <td>Probe</td> <td>Maximum</td> <td>250.00</td> </tr> <tr> <td>Calibration</td> <td>Vibrate</td> <td>Off</td> </tr> <tr> <td>Setup</td> <td></td> <td></td> </tr> </table> <p>Sets the reference thickness value.</p>	Data Logging	Limits	Off	Measurement	Minimum	0.00	Limits	Reference	0.00	Probe	Maximum	250.00	Calibration	Vibrate	Off	Setup		
Data Logging	Limits	Off																		
Measurement	Minimum	0.00																		
Limits	Reference	0.00																		
Probe	Maximum	250.00																		
Calibration	Vibrate	Off																		
Setup																				
<p>4.</p>	<p>Use the navigation keys to change the setting..</p> <p>Press the ✓ key to save. Or press the X key to exit without saving.</p>	 <p>Main Menu 14:05:44</p> <table border="1"> <tr> <td>Measurement</td> <td>Limits</td> <td>Off</td> </tr> <tr> <td>Limit</td> <td>Reference</td> <td>15.0</td> </tr> <tr> <td>Prob</td> <td></td> <td>5.0</td> </tr> <tr> <td>Calib</td> <td></td> <td>50.0</td> </tr> <tr> <td>Setup</td> <td></td> <td>Off</td> </tr> </table> <p>Sets the reference thickness value.</p>	Measurement	Limits	Off	Limit	Reference	15.0	Prob		5.0	Calib		50.0	Setup		Off			
Measurement	Limits	Off																		
Limit	Reference	15.0																		
Prob		5.0																		
Calib		50.0																		
Setup		Off																		

Deep Coat Feature (multiple echo mode)

With the Deep Coat feature turned Off and in multiple echo (ME) mode the gauge can measure through most protective coatings up to 3 mm (0.12”) thick when using a **S2C** type probe. Coatings like paint, anti-foul, hard plastics and epoxy should present no problems as long as they have not de-laminated/de-bonded from the metal surface.

With the Deep Coat feature turned On this will allow the gauge to measure through coatings over 3mm (0.12”) thick up to a maximum of around 20 mm (0.8”) depending on the properties of the coating material.

Measuring through thick coatings is ultimately limited by how well the coating material allows the ultrasound to pass through, soft coatings like rubber or bitumen don’t transmit ultrasound very well.

Using Deep Coat will not affect the calibration.

 Turn Deep Coat Off when NOT measuring through thick coatings otherwise this may cause inaccurate measurements.

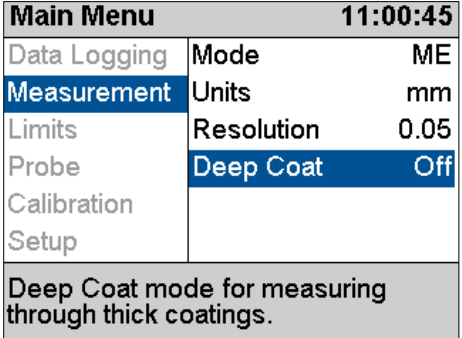
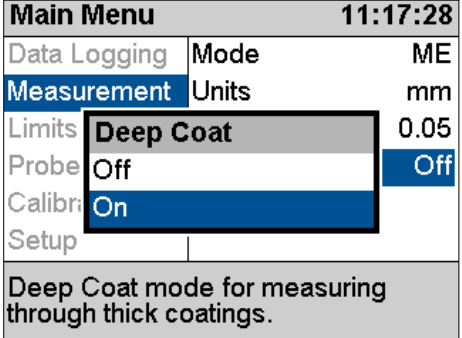
<p>1. Access the Menu and scroll down to the 'Measurement' group. Then scroll right and select 'Deep Coat'.</p> <p>Press the ✓ key to open the 'Deep Coat' option</p>		 <p>Main Menu 11:00:45</p> <table border="1"> <tr><td>Data Logging</td><td>Mode</td><td>ME</td></tr> <tr><td>Measurement</td><td>Units</td><td>mm</td></tr> <tr><td>Limits</td><td>Resolution</td><td>0.05</td></tr> <tr><td>Probe</td><td>Deep Coat</td><td>Off</td></tr> <tr><td>Calibration</td><td></td><td></td></tr> <tr><td>Setup</td><td></td><td></td></tr> </table> <p>Deep Coat mode for measuring through thick coatings.</p>	Data Logging	Mode	ME	Measurement	Units	mm	Limits	Resolution	0.05	Probe	Deep Coat	Off	Calibration			Setup		
Data Logging	Mode	ME																		
Measurement	Units	mm																		
Limits	Resolution	0.05																		
Probe	Deep Coat	Off																		
Calibration																				
Setup																				
<p>2. Use the Up and Down keys to select Deep Coat On or Off</p>		 <p>Main Menu 11:17:28</p> <table border="1"> <tr><td>Data Logging</td><td>Mode</td><td>ME</td></tr> <tr><td>Measurement</td><td>Units</td><td>mm</td></tr> <tr><td>Limits</td><td>Deep Coat</td><td>0.05</td></tr> <tr><td>Probe</td><td>Off</td><td>Off</td></tr> <tr><td>Calibr</td><td>On</td><td></td></tr> <tr><td>Setup</td><td></td><td></td></tr> </table> <p>Deep Coat mode for measuring through thick coatings.</p>	Data Logging	Mode	ME	Measurement	Units	mm	Limits	Deep Coat	0.05	Probe	Off	Off	Calibr	On		Setup		
Data Logging	Mode	ME																		
Measurement	Units	mm																		
Limits	Deep Coat	0.05																		
Probe	Off	Off																		
Calibr	On																			
Setup																				
<p>3. Press the ✓ key to save.</p> <p>Or press the X key to exit without saving.</p>																				

When the Deep Coat feature is turned On a 'DC' indicator will be displayed in the status area at the top of the measurement screen.



DC = Deep Coat is ON.

10. High Temperature Measurement

Standard twin element probes may be used to measure surface temperatures up to **75°C (160°F)**. However, for measuring at higher temperatures the T5BH High Temperature probe is available which can be used on surfaces up to **550°C (1022°F)**.

T5BH High Temperature Probe

The **T5BH** Probe can take thickness measurements at temperatures up to **300°C (570°F)**, above this temperature, measurements become harder due to the weakening ultrasonic signal caused by the high temperature effects on the material being measured.

The **T5BH** Probe can withstand temperatures up to 550°C (1022°F) providing suitable cooling cycles are observed. The graph below shows the temperature area (in green) where continuous measurement is possible, the probe should never be operated in the red area otherwise permanent damage to the probe will occur.

- Up to 350°C (662°F) – Continuous probe to hot surface contact okay.
- Over 350°C (662°F) – Intermittent probe to hot surface contact required.

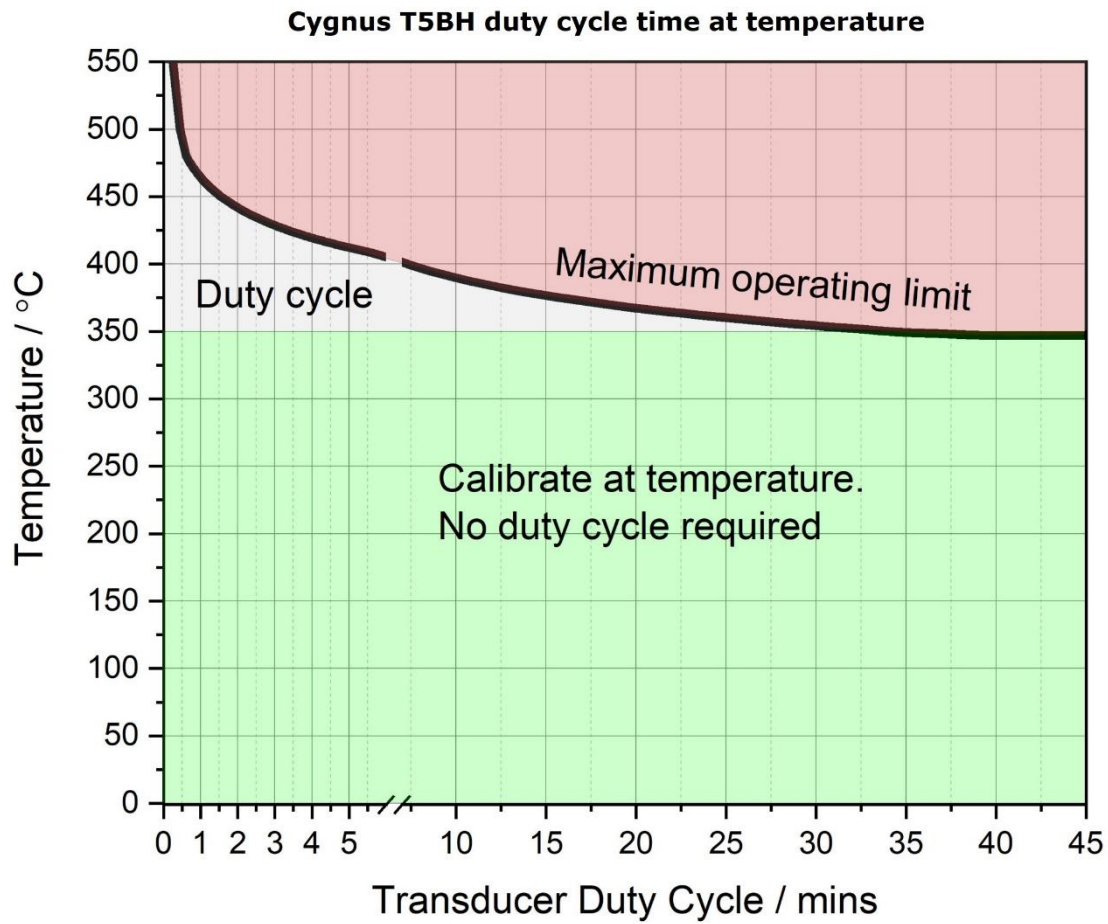

T5BH High Temperature Probe.

Velocity Change Compensation

When taking thickness measurements of metal at elevated temperatures the velocity of sound for the metal will increase as the temperature increases, this will introduce an error in the thickness measurement and must be compensated for using a simple general formula;

Reduce 1% per 55°C (100°F) rise in temperature

Temperature Compensation Feature

The gauge has a facility to apply this correction based on the surface temperature measured. The user inputs the temperature of the metal being measured and the gauge will calculate and apply the correction factor to the thickness measurements.

Excerpt from ASME V Art 23 UT;

"A rule of thumb often used is as follows:

*The apparent thickness reading obtained from steel walls having elevated temperatures is high (too thick) by a factor of about **1% per 55°C (100°F)**. Thus, if the instrument was calibrated on a piece of similar material at 20°C (68°F), and if the reading was obtained with a surface temperature of 460°C (860°F), the apparent reading should be reduced by 8%.*

This correction is an average one for many types of steel. Other corrections would have to be determined empirically for other materials.

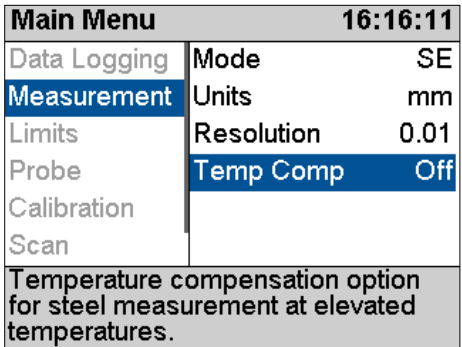
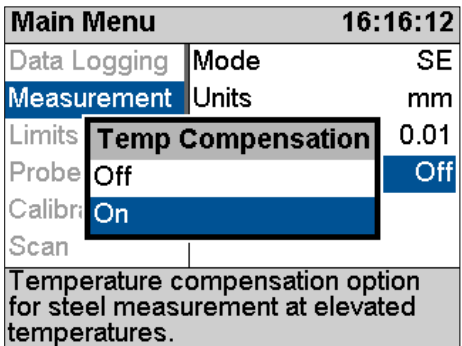
<p>1. Access the Menu and scroll down to the 'Measurement' group. Then scroll right and select 'Temp Comp'.</p> <p>Press the \checkmark key to open the 'Temp Comp' option</p>		 <p>Main Menu 16:16:11</p> <table border="1"> <tr><td>Data Logging</td><td>Mode</td><td>SE</td></tr> <tr><td>Measurement</td><td>Units</td><td>mm</td></tr> <tr><td>Limits</td><td>Resolution</td><td>0.01</td></tr> <tr><td>Probe</td><td>Temp Comp</td><td>Off</td></tr> <tr><td>Calibration</td><td></td><td></td></tr> <tr><td>Scan</td><td></td><td></td></tr> </table> <p>Temperature compensation option for steel measurement at elevated temperatures.</p>	Data Logging	Mode	SE	Measurement	Units	mm	Limits	Resolution	0.01	Probe	Temp Comp	Off	Calibration			Scan		
Data Logging	Mode	SE																		
Measurement	Units	mm																		
Limits	Resolution	0.01																		
Probe	Temp Comp	Off																		
Calibration																				
Scan																				
<p>2. Use the Up and Down keys to select Temp Comp On or Off as required followed by the \checkmark key</p>		 <p>Main Menu 16:16:12</p> <table border="1"> <tr><td>Data Logging</td><td>Mode</td><td>SE</td></tr> <tr><td>Measurement</td><td>Units</td><td>mm</td></tr> <tr><td>Limits</td><td>Temp Compensation</td><td>0.01</td></tr> <tr><td>Probe</td><td>Off</td><td>Off</td></tr> <tr><td>Calibr</td><td>On</td><td></td></tr> <tr><td>Scan</td><td></td><td></td></tr> </table> <p>Temperature compensation option for steel measurement at elevated temperatures.</p>	Data Logging	Mode	SE	Measurement	Units	mm	Limits	Temp Compensation	0.01	Probe	Off	Off	Calibr	On		Scan		
Data Logging	Mode	SE																		
Measurement	Units	mm																		
Limits	Temp Compensation	0.01																		
Probe	Off	Off																		
Calibr	On																			
Scan																				

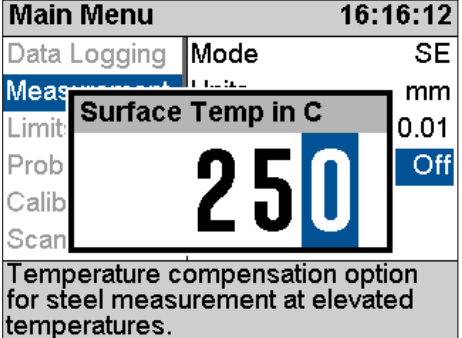
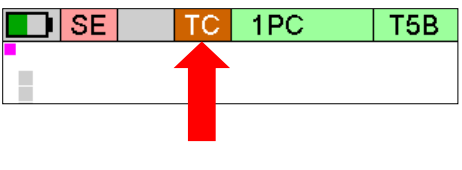
<p>3. If Temp Comp = On you will be asked to input a temperature value followed by the ✓ key</p> <p><i>This temperature can be in °C or °F depending on setup.</i></p>		 <p>The screenshot shows the 'Main Menu' at 16:16:12. A pop-up window displays 'Surface Temp in C' with the value '250'. Below the pop-up, the 'Temperature compensation option for steel measurement at elevated temperatures.' is shown as 'Off'.</p>
<p>4. A 'TC' icon at the top of the measurement screen informs the user that Temp Compensation is active.</p>		 <p>The screenshot shows the top of the measurement screen with icons for 'SE', 'TC', '1PC', and 'T5B'. A red arrow points to the 'TC' icon, indicating that Temperature Compensation is active.</p>

Taking Measurements at High Temperatures

A basic procedure for taking high temperature measurements follows, this should only be used as a guide as the operator should have the required training and experience to perform high temperature measurement.

1. Wear the appropriate PPE
2. Clear the test area ready for the UT probe removing all loose surface material and any old couplant.
3. Temperature Compensation mode should be used as this will adjust the measurements for the temperature of the material being measured. Temperature Compensation also enables manual gain to ensure that the gain can be adjusted sufficiently to obtain satisfactory measurements.
4. Set the Temperature Compensation value
5. Take a few sample measurements to heat up the probe and then re-Zero the probe whilst hot to ensure accuracy
6. View the A-Scan
7. Place the couplant on the probe face
8. Place the probe firmly on the hot surface, observe the A-Scan and measurement then adjust the gain as required, when you see a good measurement press the Freeze button and log the measurement

9. Remove the probe from the surface and allow to cool
10. Repeat from step 6.

High Temperature Couplant

Cygnus recommend HiTempco couplant from Echo Ultrasonics (www.echoultrasonics.com). HiTempco can be used for measurements up to 412°C (775°F).

11. Cross-Section B-Scan Feature

The Cross-Section B-Scan feature can be used to take a series of continuous thickness measurements and display the results graphically to represent a cross section through the material.

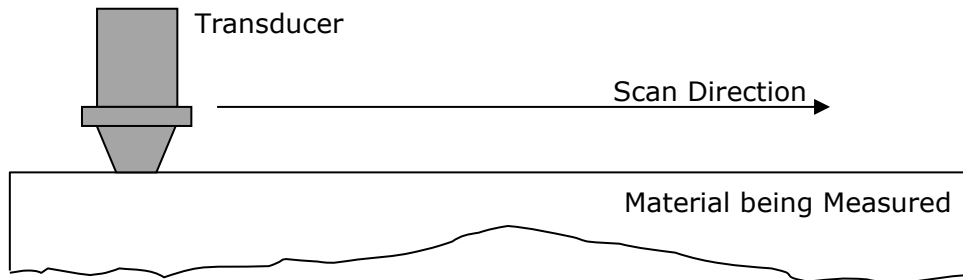

The results of the scan include a minimum thickness value. A cursor can also be positioned to pinpoint individual thickness measurements and log these to a data logger record if required. The B-Scan data is saved to a file on the SD card which can be transferred to CygLink for viewing and including in a Survey Report.

For the best results the transducer must remain in continuous contact with the surface and be moved at a constant rate – in practice however this can be tricky to achieve especially on rough surfaces.

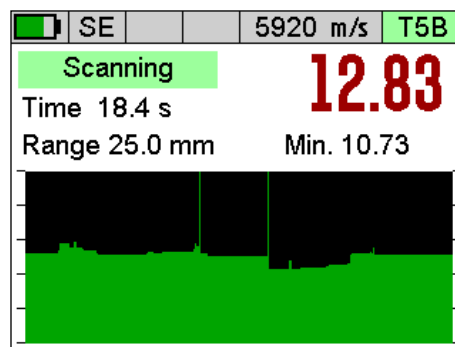

Typical B-Scan Screen.



The Cross-Section B-Scan feature is only available in Single Echo and Echo-Echo measurement modes using twin element probes.

Scan Menu Options

Range

This sets the vertical axis range which is thickness measured. You would normally set this just greater than the thickest measurement you expect.

Scan Length

This is an optional setting that can be used to specify the length of the B-Scan section. Although there is no encoder this can be used to add information to a B-Scan graph, especially when included in a PDF report.

Performing a Scan

Before starting a scan setup, set the probe and measurement options so you are able to take spot thickness measurements as required. Next set any of the Scan menu options as required.

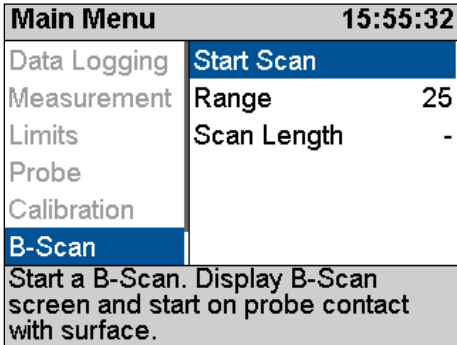
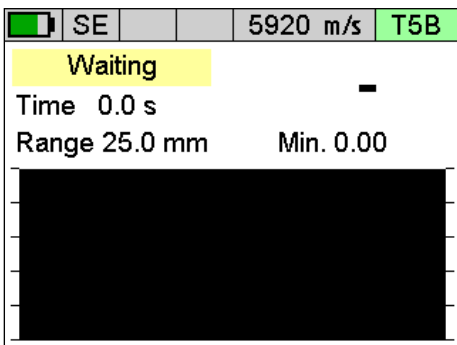
<p>1.</p>	<p>Access the Menu and scroll down to the 'Scan' group. Then scroll right and select 'Start Scan'.</p> <p>Press the \checkmark key to open the Scan screen.</p>	 <p>Main Menu 15:55:32</p> <table border="1"> <tr> <td>Data Logging</td> <td>Start Scan</td> </tr> <tr> <td>Measurement</td> <td>Range 25</td> </tr> <tr> <td>Limits</td> <td>Scan Length -</td> </tr> <tr> <td>Probe</td> <td></td> </tr> <tr> <td>Calibration</td> <td></td> </tr> <tr> <td>B-Scan</td> <td></td> </tr> </table> <p>Start a B-Scan. Display B-Scan screen and start on probe contact with surface.</p>	Data Logging	Start Scan	Measurement	Range 25	Limits	Scan Length -	Probe		Calibration		B-Scan	
Data Logging	Start Scan													
Measurement	Range 25													
Limits	Scan Length -													
Probe														
Calibration														
B-Scan														
<p>2.</p>	<p>The B-Scan screen is now waiting for the probe to make contact with the surface and begin getting thickness measurements..</p>	 <p>SE 5920 m/s T5B</p> <p>Waiting</p> <p>Time 0.0 s</p> <p>Range 25.0 mm Min. 0.00</p>												

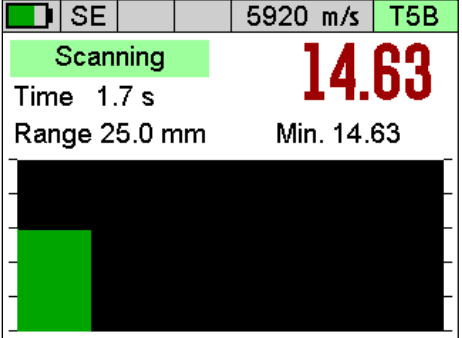
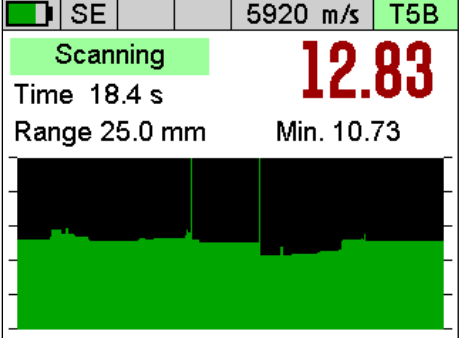
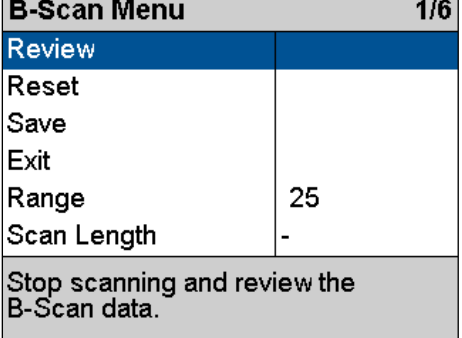
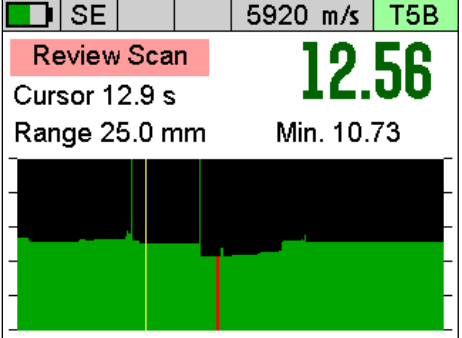
<p>3.</p>	<p>When the gauge detects the probe is coupled to a surface it will begin scanning.</p> <p>You will see the B-Scan start to build from the left to right direction.</p>									
<p>4.</p>	<p>If you lift the probe off the surface, or it loses signal, the B-Scan will pause.</p> <p>If you place the probe back on the surface the B-Scan will resume.</p>									
<p>5.</p>	<p>You can press the Menu key to view the B-Scan options;</p> <table border="1" data-bbox="319 1086 494 1534"> <tr> <td>Review</td> <td>Review the B-Scan with a movable cursor</td> </tr> <tr> <td>Reset</td> <td>Start a new B-Scan</td> </tr> <tr> <td>Save</td> <td>Save the B-Scan to a file</td> </tr> <tr> <td>Exit</td> <td>Exit the B-Scan screen</td> </tr> </table>	Review	Review the B-Scan with a movable cursor	Reset	Start a new B-Scan	Save	Save the B-Scan to a file	Exit	Exit the B-Scan screen	
Review	Review the B-Scan with a movable cursor									
Reset	Start a new B-Scan									
Save	Save the B-Scan to a file									
Exit	Exit the B-Scan screen									
<p>6.</p>	<p>In the Review screen the B-Scan is displayed.</p> <p>You can move the yellow Cursor line using the Left and Right keys. The [Cursor] value shows the thickness measurement at the cursor position.</p>									

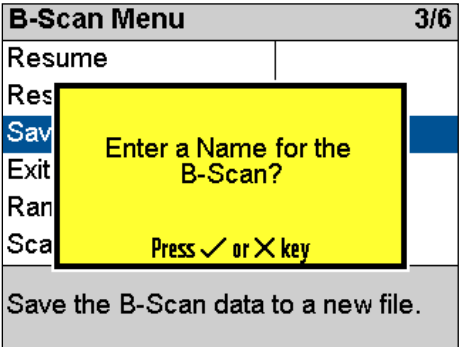
	<p>The Minimum point in the B-Scan is marked with Red vertical line(s).</p> <p>Pressing the ✓ key will log the measurement at the cursor position into the current data logger record.</p>	
<p>7.</p>	<p>If you Save the B-Scan you will be prompted for an optional Name for the B-Scan – this can be used to identify the scan in CygLink.</p> <p>B-Scan files are saved to the SD card with a date-time filename.</p>	 <p>The screenshot shows the 'B-Scan Menu' with a page indicator '3/6'. The menu items are 'Resume', 'Res', 'Sav', 'Exit', 'Ran', and 'Sca'. The 'Sav' option is highlighted with a blue bar. A yellow dialog box is overlaid on the screen with the text 'Enter a Name for the B-Scan?' and 'Press ✓ or X key'. Below the dialog box, a grey bar contains the text 'Save the B-Scan data to a new file.'</p>

12. Data Logging

There is a comprehensive Data Logging feature that allows thickness measurements and A-Scans to be saved in a data logging Record. These Records can be quickly created by the user so the measurements can be organised in separate records according to the survey being carried out. Records can later be transferred to a computer for viewing, analysis and report generation or export to a CSV file.

The process of data logging is;

1. **Create** a new Record
2. **Log** your thickness measurements - pressing the Ok key to save each thickness measurement
3. **Complete** the Record when all the measurements have been taken – the record is safely saved on the removable SD card

Record Types

There are three record types available;

1. **Linear** – this is a simple list of thickness measurements saved in the order they are taken.
2. **Grid** – this arranges the thickness measurements into a row and column grid layout. You can choose from 16 different grid patterns.
3. **Template** – this uses a custom template to specify how many thickness measurements are required along with optional additional information such as serial numbers or lists.

Reference and Minimum Thicknesses

Each record can have an optional Reference and Minimum thickness value set. When logging measurements these limits are used to colour the measurement values and in the case of the minimum limit alert the user if the measurement is under that limit.

1. **Ref. Thk.** – This is the Reference Thickness value for the whole record. If you are surveying steel that was 12mm thick when new then this would be your reference thickness.
2. **Min. Thk.** – This is the Minimum Thickness value for the whole record. If you take any measurements under this value they will be coloured Red to highlight them.

Minimum Thickness Limit Alert

When logging thickness measurements if a logged measurement falls under the Min. Thk. limit a double-vibrate alert is produced to alert the user.

Radial Points

Both Linear and Grid Records can have a set of Radial Points added to any logged thickness measurement to further detail an area of interest or heavy corrosion. The user can add up to 12 additional thickness measurements around the principal measurement in a 'clock-face' pattern.

For example, when logging thickness measurements on a pipe, tank or plate it is sometimes necessary to add additional measurement points radially around a badly corroded or thin area to detail the extent of the thinning or corrosion.

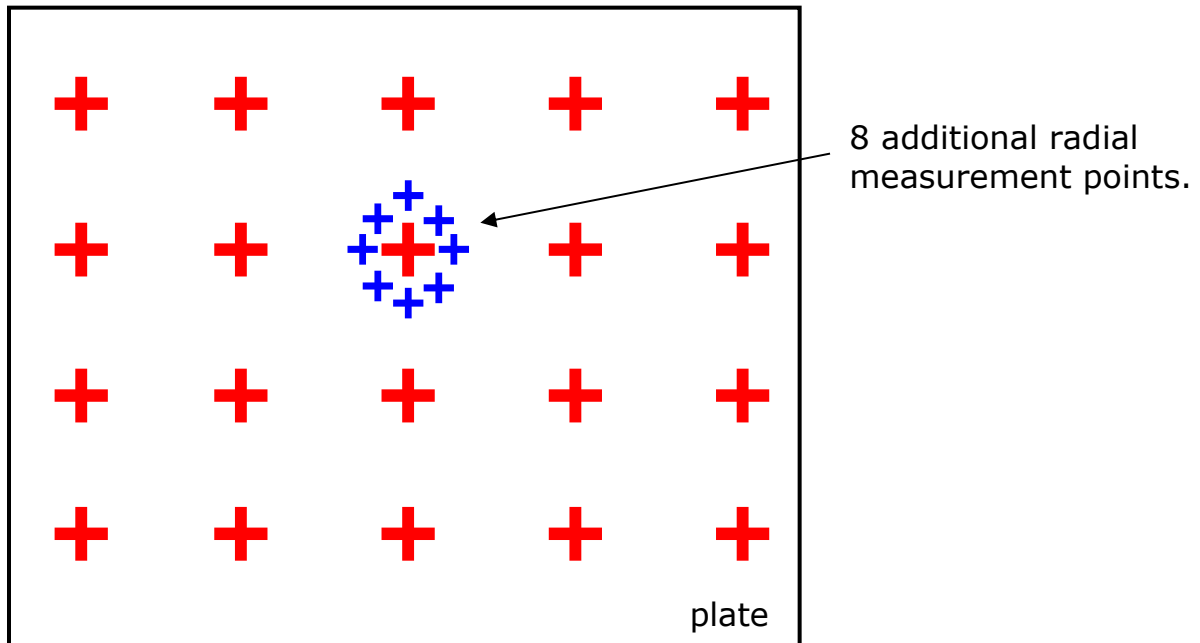

See Adding Radial Points on page 89.

Measurement Comments

Each measurement point can optionally have comments added to it. There is a list of 8 pre-set comments each of up to 24 characters in length. By having a list of pre-set comments, the user can quickly add comments by just selected the ones that are appropriate, this also standardises the information you want recording.

Typical comments for a corrosion survey could be;

1. Pitted Surface
2. Corrosion Blister
3. Corrosion Pinholes
4. Delamination
5. Coating damaged
6. Heavy corrosion
7. Repair Patch
8. Holed

See Adding Measurement Comments on page 91.

Loading Measurement Comments from a File

You can load a new set of measurement comments from a file on the SD card. The file must be named 'commentlist.txt' and contain a list of up to 8 text comments each up to 24 characters in length.

You can use Microsoft® Excel to create a list of comments, then save the file as a Text file;

File name:	commentlist.txt
Save as type:	Text (MS-DOS) (*.txt)

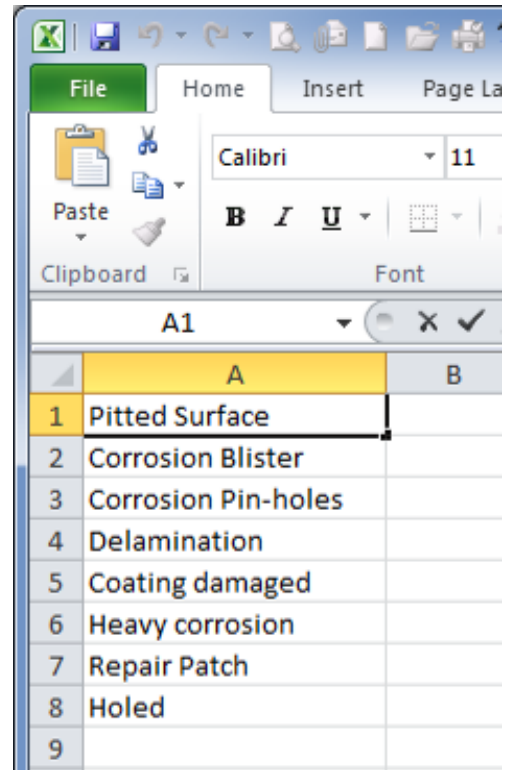

The screenshot shows the Microsoft Excel interface with a grid of measurement comments. The grid has two columns, A and B, and nine rows. The comments are listed in column A, starting from row 1. The font is Calibri, size 11, and the text is bolded.

	A	B
1	Pitted Surface	
2	Corrosion Blister	
3	Corrosion Pin-holes	
4	Delamination	
5	Coating damaged	
6	Heavy corrosion	
7	Repair Patch	
8	Holed	
9		

Grid Records

Grid Records are used to organise thickness measurements across a two-dimensional grid. The grid can be applied to flat plate or cylinders alike.

Columns across 1..50

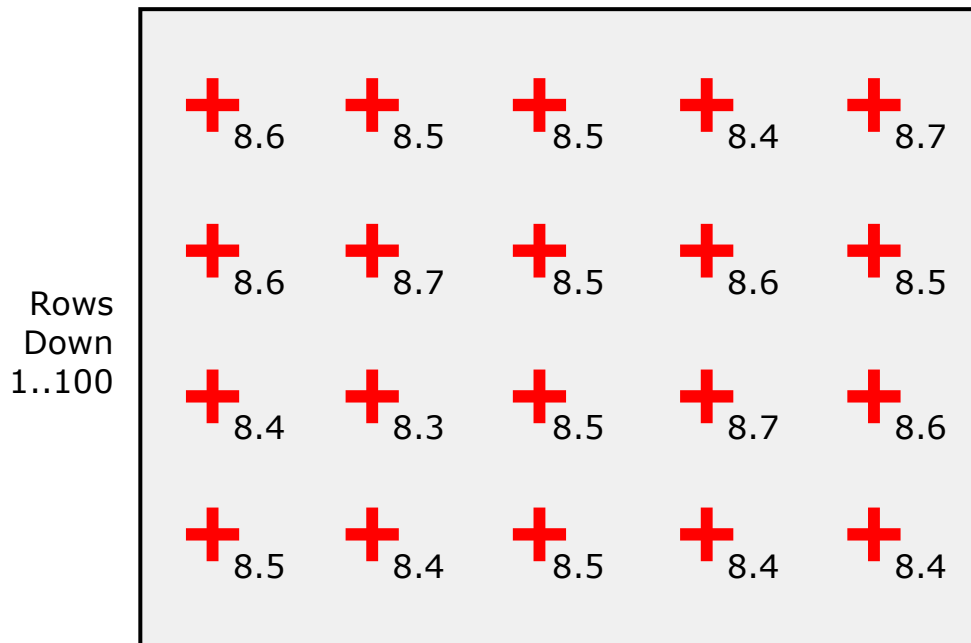

You can also choose which direction measurements will be taken, there are 16 patterns available;

Horizontal surveying	
Vertical surveying	

When a Grid Record is created the measurement point names are assigned as follows:

1. R1C1
2. R1C2
3. R1C3 etc.

The maximum number of rows and columns is 50 columns and 100 rows (5000 points).

Template Records

Templates are created with CygLink and describe the whole thickness measurement survey, defining each measurement point along with a name, reference thickness, minimum thickness and destination cell in a spreadsheet. Additional information can also be specified with 40 User Fields that can be used to prompt the user when each Record begins. Templates are normally created to cover a specific type of survey and the actual Template would be distributed to all the gauges in use within your company.

Read more about Templates in Data Logging Templates on page 100

Data Logging Menu

The Data Logging menu is conveniently at the top of the main menu list, the items listed on the right hand side will depend on whether a Record is open or closed.

Main Menu	09:47:24
Data Logging	New
Measurement	Open
Limits	Protect
Probe	Delete
Calibration	Delete All
B-Scan	
Data Logging; start and stop, add comments, new record.	
Record Closed	

Main Menu	09:55:06
Data Logging	Close
Measurement	Comments
Limits	Add Radials
Probe	Retake Last
Calibration	Step Back
B-Scan	Review
Data Logging; start and stop, add comments, new record.	
Record Open	

Creating a new Record

When you create a new record to contain your thickness measurements there are a few options you may need to edit, these will depend on the type of Record you select;

1. **Record Type** – choose from Linear, Grid or Template

2. **Name** – the gauge will automatically create a file name based on the date and time (format is `ddmmyy-hhmmss`). You can keep this filename or input a name of your own
3. **Template** – (Template only) name of the Template to use
4. **Points** – (Linear only) number of thickness measurements expected
5. **Columns** – (Grid only) number of columns required
6. **Rows** – (Grid only) number of rows required
7. **Direction** - (Grid only) grid measurement pattern, there are 16 to choose from
8. **Ref. Thk** – Reference thickness
9. **Min. Thk** – Minimum thickness
10. **Surveyor** –(optional) name of the surveyor
11. **Location** –(optional) location of the survey

<p>1. Access the Menu and scroll down to the 'Data Logging' group. Then scroll right and select 'New'.</p> <p>Press the ✓ key to open the function</p>	<table border="1" style="width: 100%; border-collapse: collapse;"> <tr> <td colspan="2" style="text-align: right;">Main Menu</td> <td style="text-align: right;">09:47:33</td> </tr> <tr> <td style="background-color: #0056b3; color: white;">Data Logging</td> <td colspan="2" style="background-color: #0056b3; color: white;">New</td> </tr> <tr> <td>Measurement</td> <td colspan="2">Open</td> </tr> <tr> <td>Limits</td> <td colspan="2">Protect</td> </tr> <tr> <td>Probe</td> <td colspan="2">Delete</td> </tr> <tr> <td>Calibration</td> <td colspan="2">Delete All</td> </tr> <tr> <td>B-Scan</td> <td colspan="2"></td> </tr> <tr> <td colspan="3" style="text-align: center;">Create a new data logging record and start logging.</td> </tr> </table>	Main Menu		09:47:33	Data Logging	New		Measurement	Open		Limits	Protect		Probe	Delete		Calibration	Delete All		B-Scan			Create a new data logging record and start logging.		
Main Menu		09:47:33																							
Data Logging	New																								
Measurement	Open																								
Limits	Protect																								
Probe	Delete																								
Calibration	Delete All																								
B-Scan																									
Create a new data logging record and start logging.																									
<p>2. Use the Up and Down keys to scroll down through the New Record list.</p> <p>To set the highlighted item press the ✓ key.</p>	<table border="1" style="width: 100%; border-collapse: collapse;"> <tr> <td colspan="2" style="text-align: right;">New Record</td> <td style="text-align: right;">1/6</td> </tr> <tr> <td style="background-color: #0056b3; color: white;">Record Type</td> <td colspan="2" style="background-color: #0056b3; color: white;">Linear</td> </tr> <tr> <td>Name</td> <td colspan="2">020315-161158</td> </tr> <tr> <td>Points</td> <td colspan="2">10</td> </tr> <tr> <td>Ref. Thk.</td> <td colspan="2">15.00</td> </tr> <tr> <td>Min. Thk.</td> <td colspan="2">5.00</td> </tr> <tr> <td>Create</td> <td colspan="2"></td> </tr> <tr> <td colspan="3" style="text-align: center;">The Record Type is Linear.</td> </tr> </table>	New Record		1/6	Record Type	Linear		Name	020315-161158		Points	10		Ref. Thk.	15.00		Min. Thk.	5.00		Create			The Record Type is Linear.		
New Record		1/6																							
Record Type	Linear																								
Name	020315-161158																								
Points	10																								
Ref. Thk.	15.00																								
Min. Thk.	5.00																								
Create																									
The Record Type is Linear.																									

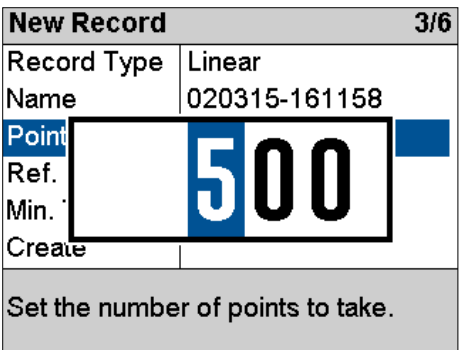
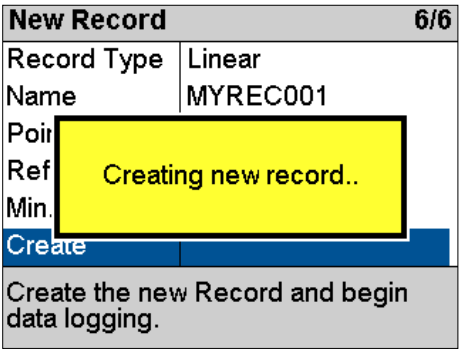
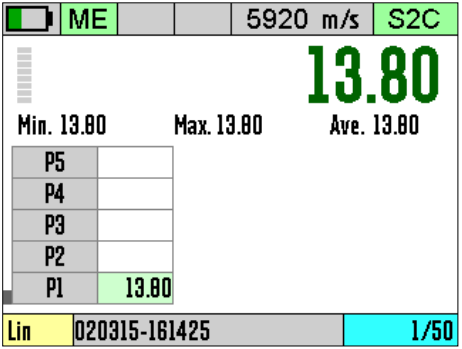
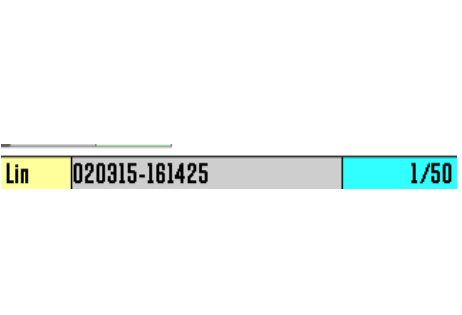
<p>3.</p>	<p>Example. Setting the number of measurement points to take in a Linear record.</p>	 <p>New Record 3/6 Record Type Linear Name 020315-161158 Point 500 Ref. Min. Create Set the number of points to take.</p>
<p>4.</p>	<p>When all the items are set as required move the highlight down to the 'Create' item and press the ✓ key.</p>	 <p>New Record 6/6 Record Type Linear Name MYREC001 Point Ref. Min. Create Creating new record.. Create the new Record and begin data logging.</p>
<p>5.</p>	<p>You can now start logging thickness measurements. The measurement screen will be moved to the Data Logging view.</p>	 <p>ME 5920 m/s S2C 13.80 Min. 13.80 Max. 13.80 Ave. 13.80 P5 P4 P3 P2 P1 13.80 Lin 020315-161425 1/50</p>
<p>6.</p>	<p>At the bottom of the screen details of the record are displayed; Record Type (Lin) Name of the Record Number of Points Taken/Total</p>	 <p>Lin 020315-161425 1/50</p>

Your Choices will be Saved for Next Time

All the items listed in the New Record list will be saved and presented next time you create a new Record (except the Name). This means you can quickly create identical records without having to re-input data each time.

Using a Template to Create a new Record

When you create a Template Record you must also select a Template to use. This Template defines the number of measurement points, their names, the measurement units, the velocity of sound and also may contain up to 40 user-defined data fields to capture text, numeric, date or list information from the user.

The process of starting a new Record from a Template is identical to starting a Linear or Grid Record, except you may be prompted for User Field information after the Record is created.

User Field Input

User Fields can prompt for Alphanumeric, Numeric, Date, List or Yes/No input from the user.

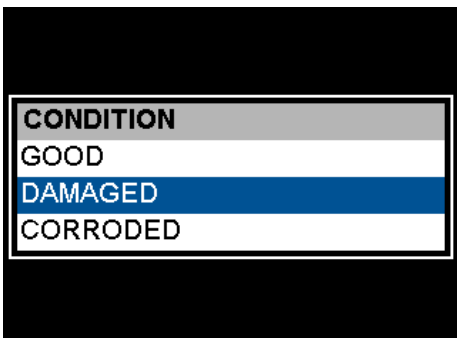
<p>1.</p>	<p>Here the User Field is requesting a Numeric Entry called "Serial No".</p> <p>The user would set the numeric value and press the ✓ key to proceed.</p>	
<p>2.</p>	<p>Here the User Field is requesting selection from a List called "Condition".</p> <p>The user would select an item and press the ✓ key to proceed.</p>	

Reviewing and Editing User Field Choices

You will be prompted for User Field information when starting a new Record based on a Template. If you decide you need to modify these choices you can access the User Fields from the menu.

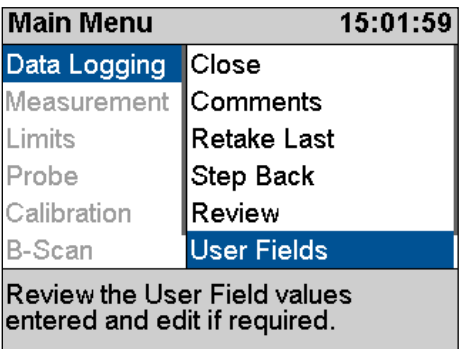
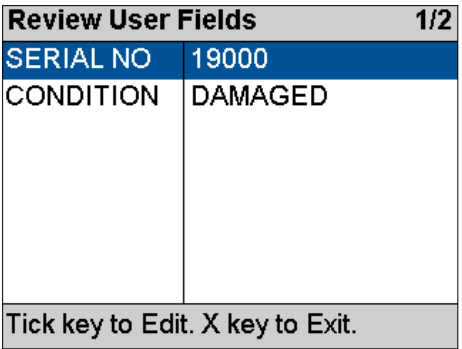
<p>1. Access the Menu and scroll down to the 'Data Logging' group. Then scroll right and select 'User Fields'.</p> <p>Press the ✓ key to open the screen</p>		
<p>2. The User Fields will be displayed; you can select using the Up and Down keys, then press the ✓ key to edit the values.</p> <p>Press the X key to exit the Review User Fields screen.</p>		

Logging Thickness Measurements

To Log a thickness measurement you press the **✓** key when a thickness value is displayed. You can do this in ANY of the three measurement screens.

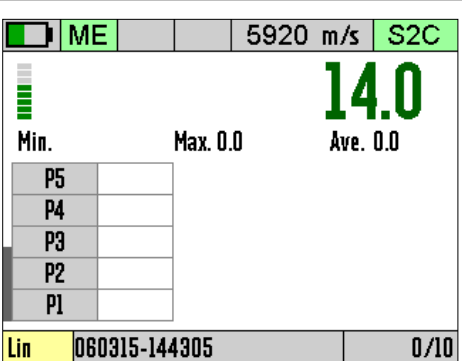
<p>1. With a thickness measurement displayed press the ✓ key once...</p>		
--	--	--

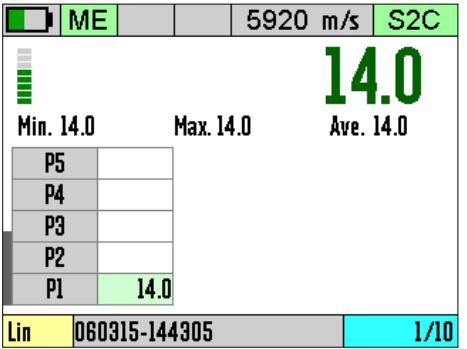
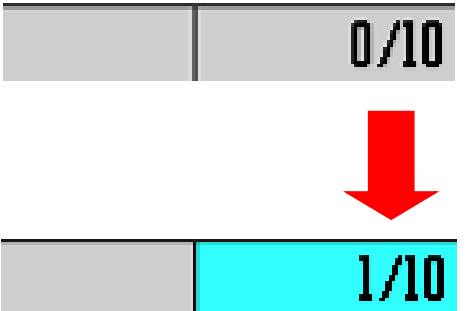
<p>2.</p>	<p>...the thickness measurement is added to the list, in this example it's at 'P1' as it's the first measurement.</p>	
<p>3.</p>	<p>The 'number of records' indication changes colour to light blue for a second afterwards to indicate the measurement has just been logged ok.</p>	

Auto-Log Feature

The gauge has an Auto-Log feature that will automatically log thickness measurements when the measurement remains stable for two seconds. This means the operator can log measurements using one hand.

See Auto-Log on page 114 to turn the Auto-Log feature On or Off.

The Auto-Log sequence is as follows;

1. Place the probe on the surface and obtain a measurement
2. Hold the probe still to ensure the measurement remains stable..
3. After 2 seconds of stable measurement the value will be Auto-Logged
4. Remove the probe from the surface and wait until the 'number of records' indication turns from blue to grey before taking the next measurement, this is about 1 second.

Logging Obstructions and No-Readings

When surveying there may be measurement points that are inaccessible due to an object being in the way or there may be points where thickness readings can't be obtained (due to excessive corrosion and thinning for example). The Gauge allows the user to record either a No-Reading or Obstructed measurement point as required

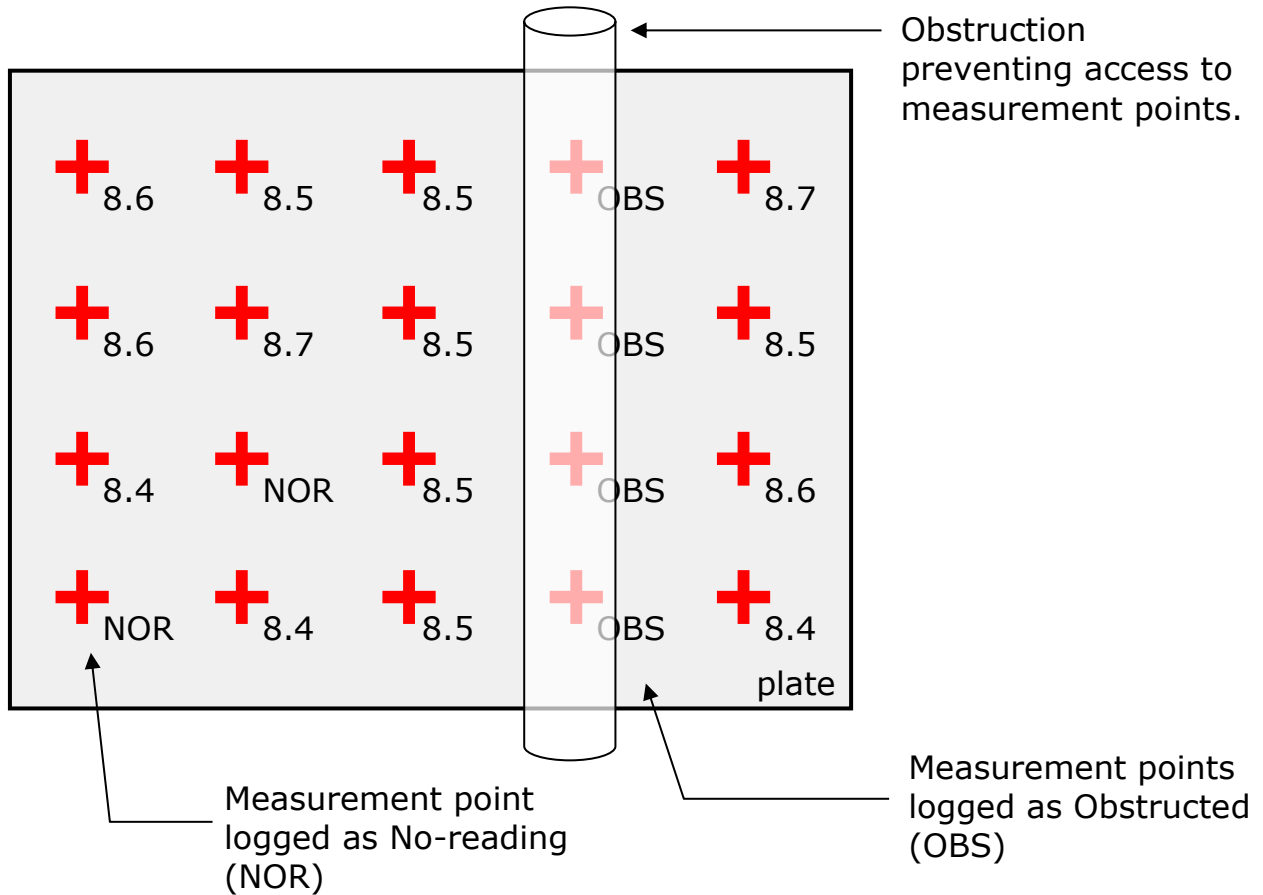

<p>1. With NO thickness measurement displayed press the ✓ key once...</p> <p>Then choose No Reading or Obstructed using the ✓ and Cancel keys.</p>	<p>ME 5920 m/s S2C</p> <p>Min.</p> <p>✓ = No Reading ✗ = Obstructed</p> <p>P1 14.0</p> <p>Lin 060315-144305 3/10</p>
---	--

<p>2.</p>	<p>...the tag is added to the list, in this example its No Reading 'NR' at 'P4'</p>	
<p>3.</p>	<p>in this example its Obstructed 'Obs' at 'P5'</p>	

Changing Measurement Units while Data Logging

When a Record is active you will be unable to change the measurement units. This is because each record can only contain measurements of the same units. If you try and change the measurement units you will get this message;

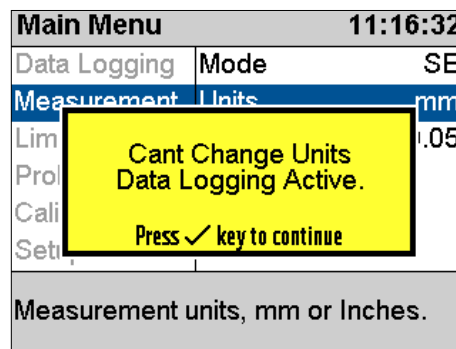

Re-taking the Last Measurement

If you make a mistake and need to Re-Take the last measurement the Retake Last menu item will do this quickly.

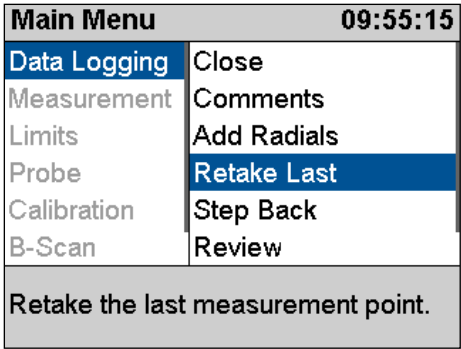
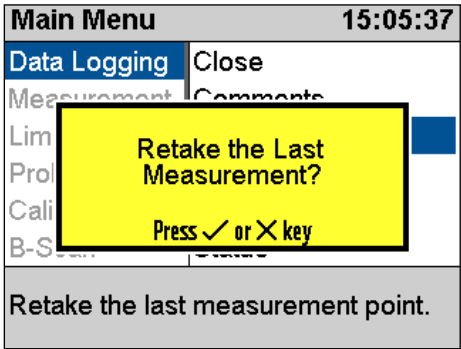
<p>1.</p>	<p>Access the Menu and scroll down to the 'Data Logging' group. Then scroll right and select 'Retake Last'.</p> <p>Press the ✓ key to select</p>	 <p>Main Menu 09:55:15</p> <table border="1"> <tr><td>Data Logging</td><td>Close</td></tr> <tr><td>Measurement</td><td>Comments</td></tr> <tr><td>Limits</td><td>Add Radials</td></tr> <tr><td>Probe</td><td>Retake Last</td></tr> <tr><td>Calibration</td><td>Step Back</td></tr> <tr><td>B-Scan</td><td>Review</td></tr> </table> <p>Retake the last measurement point.</p>	Data Logging	Close	Measurement	Comments	Limits	Add Radials	Probe	Retake Last	Calibration	Step Back	B-Scan	Review
Data Logging	Close													
Measurement	Comments													
Limits	Add Radials													
Probe	Retake Last													
Calibration	Step Back													
B-Scan	Review													
<p>2.</p>	<p>Confirm by pressing the ✓ key.</p>	 <p>Main Menu 15:05:37</p> <table border="1"> <tr><td>Data Logging</td><td>Close</td></tr> <tr><td>Measurement</td><td>Comments</td></tr> <tr><td>Lim</td><td></td></tr> <tr><td>Pro</td><td></td></tr> <tr><td>Cal</td><td></td></tr> <tr><td>B-S</td><td></td></tr> </table> <p>Retake the Last Measurement?</p> <p>Press ✓ or X key</p> <p>Retake the last measurement point.</p>	Data Logging	Close	Measurement	Comments	Lim		Pro		Cal		B-S	
Data Logging	Close													
Measurement	Comments													
Lim														
Pro														
Cal														
B-S														
<p>3.</p>	<p>The last measurement point has now been removed from the record.</p>													

Stepping Backwards in the Record

If you need to step backwards in the record and re-take the measurement points from that point then use the Step Back menu item.

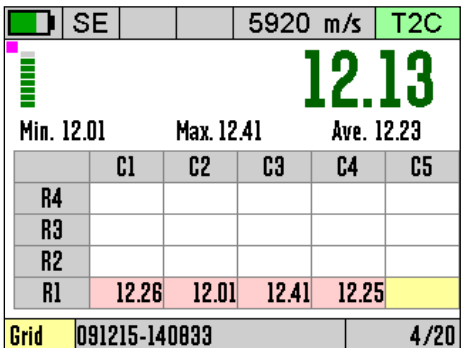
<p>1.</p>	<p>Assume you have logged 4 measurements (C1, C2, C3 & C4) but need to go back to the second measurement (C2) and re-take from that point.</p>	 <p>SE 5920 m/s T2C</p> <p>12.13</p> <p>Min. 12.01 Max. 12.41 Ave. 12.23</p> <table border="1"> <thead> <tr><th></th><th>C1</th><th>C2</th><th>C3</th><th>C4</th><th>C5</th></tr> </thead> <tbody> <tr><td>R4</td><td></td><td></td><td></td><td></td><td></td></tr> <tr><td>R3</td><td></td><td></td><td></td><td></td><td></td></tr> <tr><td>R2</td><td></td><td></td><td></td><td></td><td></td></tr> <tr><td>R1</td><td>12.26</td><td>12.01</td><td>12.41</td><td>12.25</td><td></td></tr> </tbody> </table> <p>Grid 091215-140833 4/20</p>		C1	C2	C3	C4	C5	R4						R3						R2						R1	12.26	12.01	12.41	12.25	
	C1	C2	C3	C4	C5																											
R4																																
R3																																
R2																																
R1	12.26	12.01	12.41	12.25																												

<p>2.</p>	<p>Access the Menu and scroll down to the 'Data Logging' group. Then scroll right and select 'Step Back'.</p> <p>Press the ✓ key to select</p>	<table border="1"> <tr> <td colspan="2">Main Menu</td> <td>13:56:54</td> </tr> <tr> <td>Data Logging</td> <td>Close</td> <td></td> </tr> <tr> <td>Measurement</td> <td>Comments</td> <td></td> </tr> <tr> <td>Limits</td> <td>Retake Last</td> <td></td> </tr> <tr> <td>Probe</td> <td>Step Back</td> <td></td> </tr> <tr> <td>Calibration</td> <td>Review</td> <td></td> </tr> <tr> <td>B-Scan</td> <td>Status</td> <td></td> </tr> </table> <p>Step back and retake measurement points from that position.</p>	Main Menu		13:56:54	Data Logging	Close		Measurement	Comments		Limits	Retake Last		Probe	Step Back		Calibration	Review		B-Scan	Status																																		
Main Menu		13:56:54																																																						
Data Logging	Close																																																							
Measurement	Comments																																																							
Limits	Retake Last																																																							
Probe	Step Back																																																							
Calibration	Review																																																							
B-Scan	Status																																																							
<p>3.</p>	<p>A view of the Record's measurement points is displayed; you can use the navigation keys to move back to the required point (C2) in the record. The selected point is highlighted purple (arrowed).</p> <p>Press ✓ to select. Press Cancel to abort.</p>	<table border="1"> <tr> <td colspan="6">Set Next Measurement Point</td> </tr> <tr> <td></td> <td>C1</td> <td>C2</td> <td>C3</td> <td>C4</td> <td>C5</td> </tr> <tr> <td></td> <td></td> <td></td> <td></td> <td></td> <td></td> </tr> <tr> <td></td> <td></td> <td></td> <td></td> <td></td> <td></td> </tr> <tr> <td>R4</td> <td></td> <td></td> <td></td> <td></td> <td></td> </tr> <tr> <td>R3</td> <td></td> <td></td> <td></td> <td></td> <td></td> </tr> <tr> <td>R2</td> <td></td> <td></td> <td></td> <td></td> <td></td> </tr> <tr> <td>R1</td> <td>12.26</td> <td>12.01</td> <td>12.41</td> <td>12.25</td> <td></td> </tr> <tr> <td>Grid</td> <td colspan="3">091215-140833</td> <td colspan="2">4/20</td> </tr> </table>	Set Next Measurement Point							C1	C2	C3	C4	C5													R4						R3						R2						R1	12.26	12.01	12.41	12.25		Grid	091215-140833			4/20	
Set Next Measurement Point																																																								
	C1	C2	C3	C4	C5																																																			
R4																																																								
R3																																																								
R2																																																								
R1	12.26	12.01	12.41	12.25																																																				
Grid	091215-140833			4/20																																																				
<p>4.</p>	<p>You can start logging measurements from that point.</p> <p>Note. Subsequent measurement will be overwritten.</p> <p>The next position that will be logged into is filled Yellow in colour (C2).</p>	<table border="1"> <tr> <td>SE</td> <td></td> <td>5920 m/s</td> <td>T2C</td> </tr> <tr> <td>Min.</td> <td>12.01</td> <td>Max.</td> <td>12.41</td> </tr> <tr> <td></td> <td></td> <td>Ave.</td> <td>12.23</td> </tr> <tr> <td></td> <td>C1</td> <td>C2</td> <td>C3</td> <td>C4</td> <td>C5</td> </tr> <tr> <td>R4</td> <td></td> <td></td> <td></td> <td></td> <td></td> </tr> <tr> <td>R3</td> <td></td> <td></td> <td></td> <td></td> <td></td> </tr> <tr> <td>R2</td> <td></td> <td></td> <td></td> <td></td> <td></td> </tr> <tr> <td>R1</td> <td>12.26</td> <td>12.01</td> <td>12.41</td> <td>12.25</td> <td></td> </tr> <tr> <td>Grid</td> <td colspan="3">091215-140833</td> <td colspan="2">1/20</td> </tr> </table>	SE		5920 m/s	T2C	Min.	12.01	Max.	12.41			Ave.	12.23		C1	C2	C3	C4	C5	R4						R3						R2						R1	12.26	12.01	12.41	12.25		Grid	091215-140833			1/20							
SE		5920 m/s	T2C																																																					
Min.	12.01	Max.	12.41																																																					
		Ave.	12.23																																																					
	C1	C2	C3	C4	C5																																																			
R4																																																								
R3																																																								
R2																																																								
R1	12.26	12.01	12.41	12.25																																																				
Grid	091215-140833			1/20																																																				

Adding Radial Points

You can only add Radial Points to a thickness measurement you have just logged. So you must have logged at least 1 thickness measurement in the current Record before adding Radial Points.

You cannot add Radial Points to a Template Record.

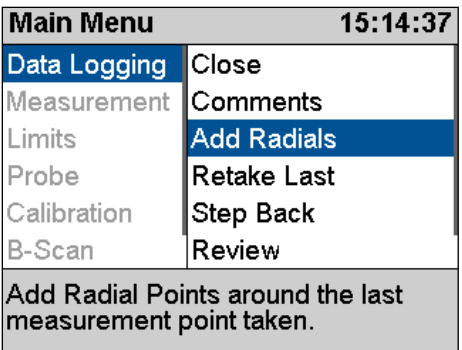
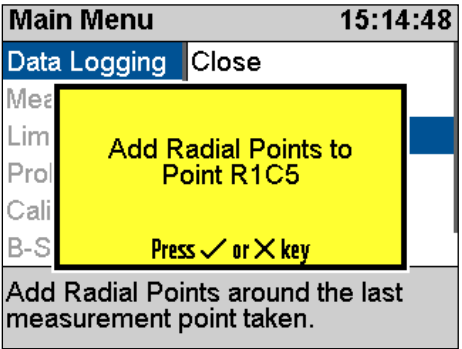
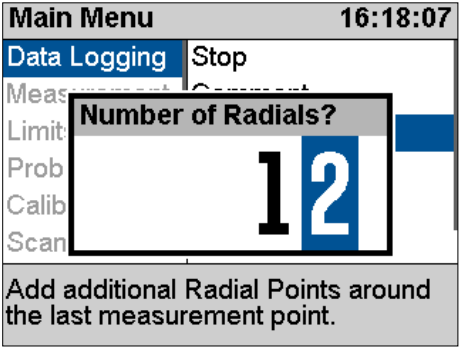
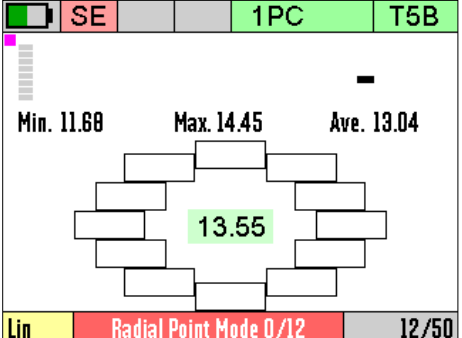

<p>1.</p>	<p>Access the Menu and scroll down to the 'Data Logging' group. Then scroll right and select 'Add Radials'.</p> <p>Press the ✓ key to select</p>	 <p>Main Menu 15:14:37</p> <ul style="list-style-type: none"> Data Logging Close Measurement Comments Limits Add Radials Probe Retake Last Calibration Step Back B-Scan Review <p>Add Radial Points around the last measurement point taken.</p>
<p>2.</p>	<p>Press the ✓ key again to confirm</p>	 <p>Main Menu 15:14:48</p> <ul style="list-style-type: none"> Data Logging Close <p>Add Radial Points to Point R1C5</p> <p>Press ✓ or X key</p> <p>Add Radial Points around the last measurement point taken.</p>
<p>3.</p>	<p>Set the number of Radial Points - this can be any number from 4 to 12</p> <p>Press the ✓ key to continue</p>	 <p>Main Menu 16:18:07</p> <ul style="list-style-type: none"> Data Logging Stop <p>Number of Radials?</p> <p>12</p> <p>Add additional Radial Points around the last measurement point.</p>
<p>4.</p>	<p>The Measurement Screen now shows the Radial Point view</p> <p>There will be empty white boxes arranged around the Parent measurement..</p>	 <p>SE 1PC T5B</p> <p>Min. 11.68 Max. 14.45 Ave. 13.04</p> <p>13.55</p> <p>Lin Radial Point Mode 0/12 12/50</p>

<p>5. ..these boxes will fill clockwise with the Radial Points measurements as they get logged</p>		
<p>6. When the last Radial Point has been logged the screen will revert back to the normal data logging view.</p>	<p>A small 'R' is added to the measurement point to show it has Radial Points added.</p>	

Adding Measurement Comments

You can add comments to ANY measurement point in the current Record, this includes Radial Points also.

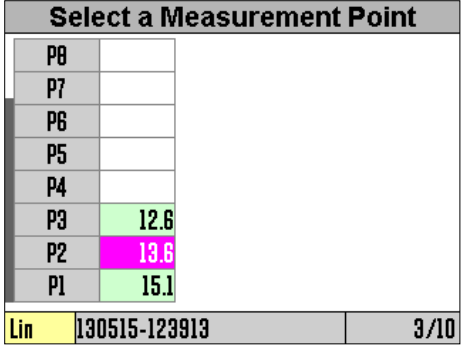
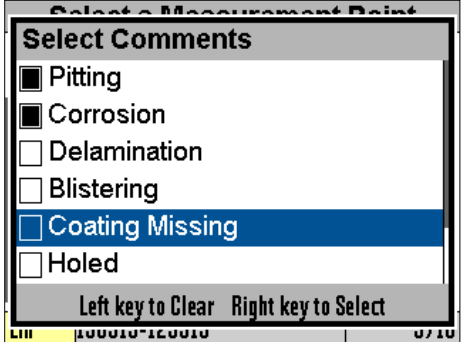
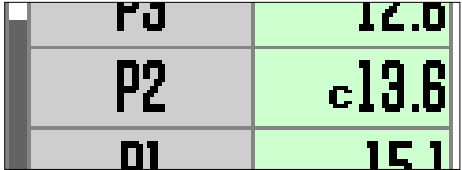

<p>1. Access the Menu and scroll down to the 'Data Logging' group. Then scroll right and select 'Comment'.</p> <p>Press the ✓ key to select</p>		
---	--	--

<p>2.</p>	<p>Use the Up and Down keys to select the measurement point you want to add Comments to, then press the ✓ key.</p>	 <p>Select a Measurement Point</p> <table border="1"> <tr><td>P8</td><td></td></tr> <tr><td>P7</td><td></td></tr> <tr><td>P6</td><td></td></tr> <tr><td>P5</td><td></td></tr> <tr><td>P4</td><td></td></tr> <tr><td>P3</td><td>12.6</td></tr> <tr><td>P2</td><td>13.6</td></tr> <tr><td>P1</td><td>15.1</td></tr> </table> <p>Lin 130515-123913 3/10</p>	P8		P7		P6		P5		P4		P3	12.6	P2	13.6	P1	15.1
P8																		
P7																		
P6																		
P5																		
P4																		
P3	12.6																	
P2	13.6																	
P1	15.1																	
<p>3.</p>	<p>Use the Up and Down keys to select the required comment,</p> <p>Use the Left and Right keys to Select or Clear the comment – a solid black box means the comment is Selected.</p> <p>When you have selected the required comments press the ✓ key to save and exit, or the X to cancel.</p>	 <p>Select Comments</p> <ul style="list-style-type: none"> <input checked="" type="checkbox"/> Pitting <input checked="" type="checkbox"/> Corrosion <input type="checkbox"/> Delamination <input type="checkbox"/> Blistering <input checked="" type="checkbox"/> Coating Missing <input type="checkbox"/> Holed <p>Left key to Clear Right key to Select</p> <p>Lin 130515-123913 3/10</p>																
<p>4.</p>	<p>In the measurement screen any measurement points that have comments will have a 'C' displayed in the measurement cell.</p>	 <table border="1"> <tr><td>P3</td><td>12.6</td></tr> <tr><td>P2</td><td>C13.6</td></tr> <tr><td>P1</td><td>15.1</td></tr> </table>	P3	12.6	P2	C13.6	P1	15.1										
P3	12.6																	
P2	C13.6																	
P1	15.1																	
<p>5.</p>	<p>When Reviewing a Record any measurement point with a 'C' (having comments) these comments can also be displayed.</p>	 <p>Review Record</p> <table border="1"> <tr><td>P3</td><td><input type="checkbox"/> Pitting</td></tr> <tr><td>P2</td><td><input checked="" type="checkbox"/> Pitting</td></tr> <tr><td>P2</td><td><input checked="" type="checkbox"/> Corrosion</td></tr> <tr><td>P1</td><td><input type="checkbox"/> Pitting</td></tr> <tr><td>P1</td><td><input type="checkbox"/> Corrosion</td></tr> </table> <p>Lin 130515-123913 3/10</p>	P3	<input type="checkbox"/> Pitting	P2	<input checked="" type="checkbox"/> Pitting	P2	<input checked="" type="checkbox"/> Corrosion	P1	<input type="checkbox"/> Pitting	P1	<input type="checkbox"/> Corrosion						
P3	<input type="checkbox"/> Pitting																	
P2	<input checked="" type="checkbox"/> Pitting																	
P2	<input checked="" type="checkbox"/> Corrosion																	
P1	<input type="checkbox"/> Pitting																	
P1	<input type="checkbox"/> Corrosion																	

Closing and Opening a Record

You can close the record and stop data logging at any time and continue to use the gauge as normal. Then later open the record again and resume where you left it.

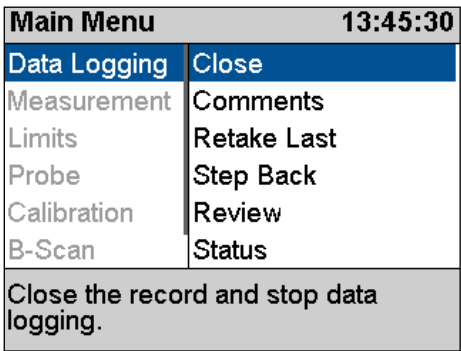
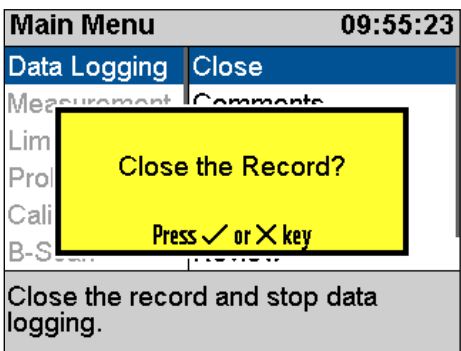
Closing the Record

<p>1. Access the Menu and scroll down to the 'Data Logging' group. Then scroll right and select 'Close.'</p> <p>Press the ✓ key to select</p>		
<p>2. Confirm by pressing the ✓ key.</p>		
<p>3. Data logging has been stopped and the record has been closed.</p> <p>The record details at the bottom of the screen bar shows "Off"</p>		

Opening a Record

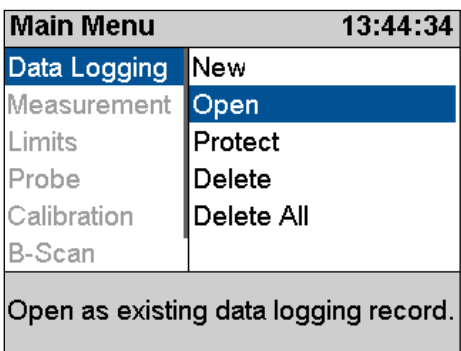
<p>1. Access the Menu and scroll down to the 'Data Logging' group. Then scroll right and select 'Open'.</p> <p>Press the ✓ key to select</p>		
---	--	--

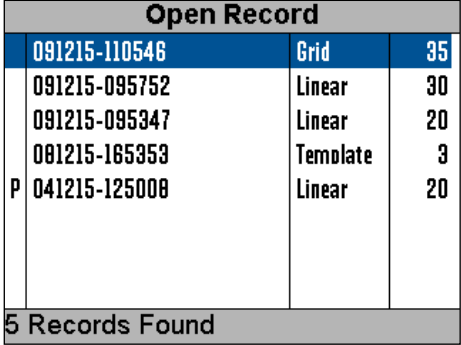
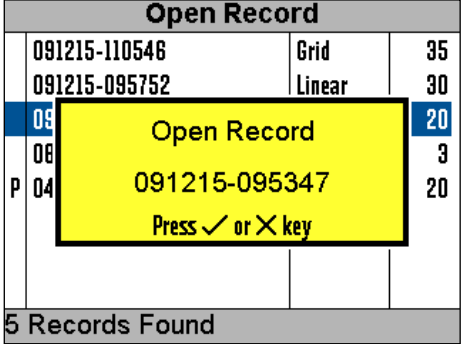
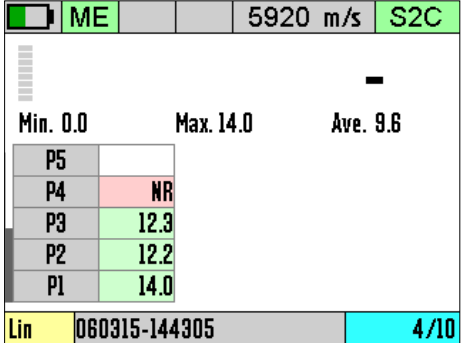
<p>2.</p>	<p>Select the Record to open, the most recent is at the top of the list.</p> <p>Confirm by pressing the ✓ key.</p>	 <table border="1"> <thead> <tr> <th colspan="3">Open Record</th> </tr> </thead> <tbody> <tr> <td>091215-110546</td> <td>Grid</td> <td>35</td> </tr> <tr> <td>091215-095752</td> <td>Linear</td> <td>30</td> </tr> <tr> <td>091215-095347</td> <td>Linear</td> <td>20</td> </tr> <tr> <td>081215-165353</td> <td>Template</td> <td>3</td> </tr> <tr> <td>P 041215-125008</td> <td>Linear</td> <td>20</td> </tr> </tbody> </table> <p>5 Records Found</p>	Open Record			091215-110546	Grid	35	091215-095752	Linear	30	091215-095347	Linear	20	081215-165353	Template	3	P 041215-125008	Linear	20						
Open Record																										
091215-110546	Grid	35																								
091215-095752	Linear	30																								
091215-095347	Linear	20																								
081215-165353	Template	3																								
P 041215-125008	Linear	20																								
<p>3.</p>	<p>Confirm by pressing the ✓ key.</p>	 <table border="1"> <thead> <tr> <th colspan="3">Open Record</th> </tr> </thead> <tbody> <tr> <td>091215-110546</td> <td>Grid</td> <td>35</td> </tr> <tr> <td>091215-095752</td> <td>Linear</td> <td>30</td> </tr> <tr> <td>091215-095347</td> <td>Linear</td> <td>20</td> </tr> <tr> <td>081215-165353</td> <td>Template</td> <td>3</td> </tr> <tr> <td>P 041215-125008</td> <td>Linear</td> <td>20</td> </tr> </tbody> </table> <p>5 Records Found</p>	Open Record			091215-110546	Grid	35	091215-095752	Linear	30	091215-095347	Linear	20	081215-165353	Template	3	P 041215-125008	Linear	20						
Open Record																										
091215-110546	Grid	35																								
091215-095752	Linear	30																								
091215-095347	Linear	20																								
081215-165353	Template	3																								
P 041215-125008	Linear	20																								
<p>4.</p>	<p>The record has been opened and data logging record has been resumed.</p>	 <table border="1"> <tr> <td>ME</td> <td>5920 m/s</td> <td>S2C</td> </tr> <tr> <td>Min. 0.0</td> <td>Max. 14.0</td> <td>Ave. 9.6</td> </tr> <tr> <td>P5</td> <td></td> <td></td> </tr> <tr> <td>P4</td> <td>NR</td> <td></td> </tr> <tr> <td>P3</td> <td>12.3</td> <td></td> </tr> <tr> <td>P2</td> <td>12.2</td> <td></td> </tr> <tr> <td>P1</td> <td>14.0</td> <td></td> </tr> <tr> <td>Lin</td> <td>060315-144305</td> <td>4/10</td> </tr> </table>	ME	5920 m/s	S2C	Min. 0.0	Max. 14.0	Ave. 9.6	P5			P4	NR		P3	12.3		P2	12.2		P1	14.0		Lin	060315-144305	4/10
ME	5920 m/s	S2C																								
Min. 0.0	Max. 14.0	Ave. 9.6																								
P5																										
P4	NR																									
P3	12.3																									
P2	12.2																									
P1	14.0																									
Lin	060315-144305	4/10																								

Protecting a Record

If you want to Protect a record from being deleted or modified then you can use the Protect Record feature. Once protected records cannot be deleted from the gauge and they cannot be re-opened and amended or changed.

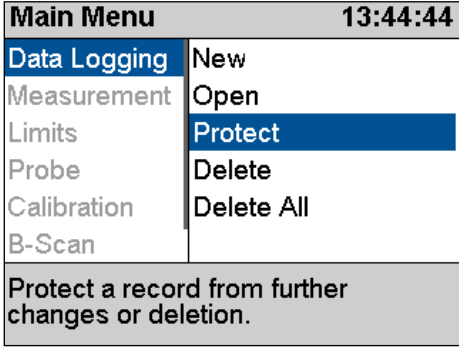
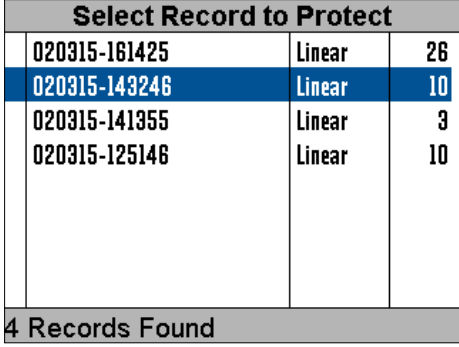
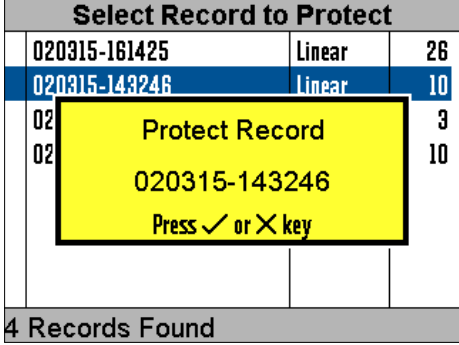

Once you protect a record then you will be unable to un-protect the record from the gauge. You can however remove the SD card and deleted the record files from the SD card using a computer.

<p>1.</p>	<p>Access the Menu and scroll down to the 'Data Logging' group. Then scroll right and select 'Protect'.</p> <p>Press the ✓ key to select</p>	 <p>Main Menu 13:44:44</p> <table border="1"> <tr><td>Data Logging</td><td>New</td></tr> <tr><td>Measurement</td><td>Open</td></tr> <tr><td>Limits</td><td>Protect</td></tr> <tr><td>Probe</td><td>Delete</td></tr> <tr><td>Calibration</td><td>Delete All</td></tr> <tr><td>B-Scan</td><td></td></tr> </table> <p>Protect a record from further changes or deletion.</p>	Data Logging	New	Measurement	Open	Limits	Protect	Probe	Delete	Calibration	Delete All	B-Scan	
Data Logging	New													
Measurement	Open													
Limits	Protect													
Probe	Delete													
Calibration	Delete All													
B-Scan														
<p>2.</p>	<p>You will see a list of all the records stored on the gauges SD card listed in newest first order.</p> <p>Use the navigation keys to select the record to protect, and then press the ✓ key.</p>	 <p>Select Record to Protect</p> <table border="1"> <tr><td>020315-161425</td><td>Linear</td><td>26</td></tr> <tr><td>020315-143246</td><td>Linear</td><td>10</td></tr> <tr><td>020315-141355</td><td>Linear</td><td>3</td></tr> <tr><td>020315-125146</td><td>Linear</td><td>10</td></tr> </table> <p>4 Records Found</p>	020315-161425	Linear	26	020315-143246	Linear	10	020315-141355	Linear	3	020315-125146	Linear	10
020315-161425	Linear	26												
020315-143246	Linear	10												
020315-141355	Linear	3												
020315-125146	Linear	10												
<p>3.</p>	<p>Confirm by pressing the ✓ key.</p>	 <p>Select Record to Protect</p> <table border="1"> <tr><td>020315-161425</td><td>Linear</td><td>26</td></tr> <tr><td>020315-143246</td><td>Linear</td><td>10</td></tr> <tr><td>02</td><td></td><td>3</td></tr> <tr><td>02</td><td></td><td>10</td></tr> </table> <p>Protect Record 020315-143246 Press ✓ or X key</p> <p>4 Records Found</p>	020315-161425	Linear	26	020315-143246	Linear	10	02		3	02		10
020315-161425	Linear	26												
020315-143246	Linear	10												
02		3												
02		10												

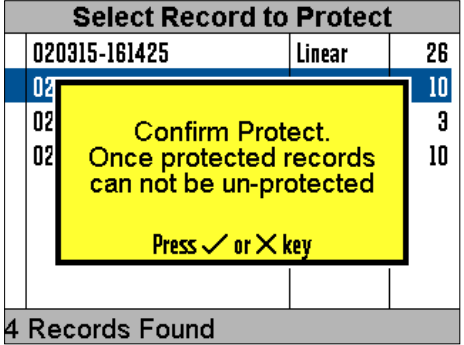
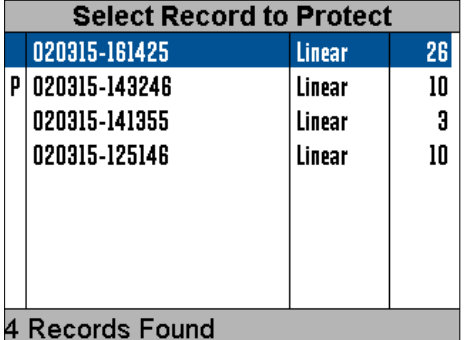
<p>4.</p>	<p>Confirm again by pressing the ✓ key.</p>	
<p>5.</p>	<p>The selected record has now been protected. When the record list is shown in the future a 'P' will appear next to any protected records.</p>	

Opening Protected Records

If you open a protected record then you will not be able to make changes to the record, you will only be able to review the records contents.

Deleting Records

You have two options for deleting Records from the gauges SD card; deleting each Record at a time, or deleting all Records at once.





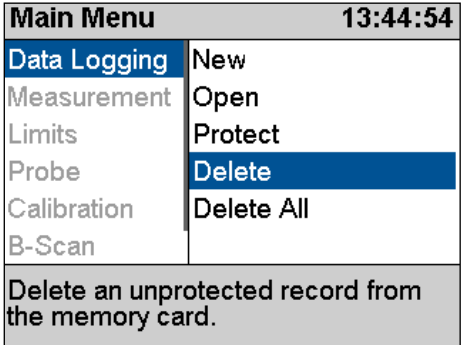
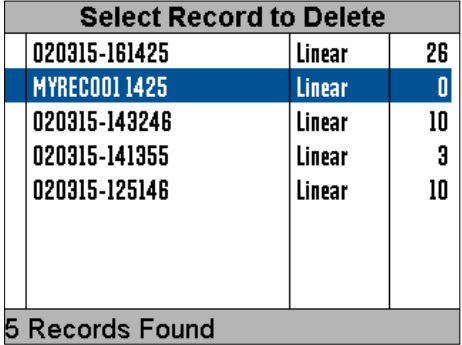
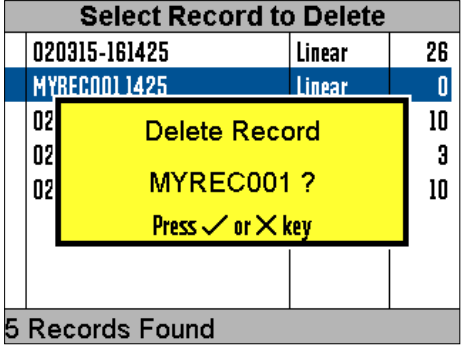
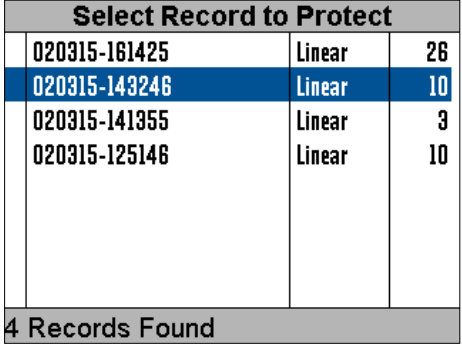

Once deleted records cannot be restored – there is no undo function.

Deleting Individual Records

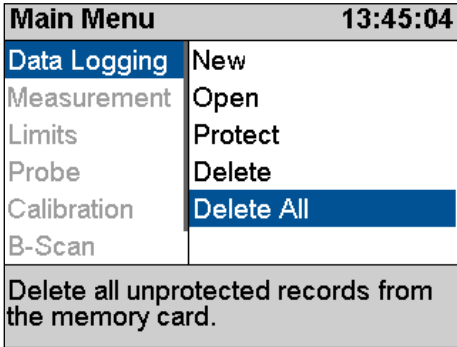
<p>1.</p>	<p>Access the Menu and scroll down to the 'Data Logging' group. Then scroll right and select 'Delete'.</p> <p>Press the ✓ key to select</p>	 <p>Main Menu 13:44:54</p> <table border="1"> <tr><td>Data Logging</td><td>New</td></tr> <tr><td>Measurement</td><td>Open</td></tr> <tr><td>Limits</td><td>Protect</td></tr> <tr><td>Probe</td><td>Delete</td></tr> <tr><td>Calibration</td><td>Delete All</td></tr> <tr><td>B-Scan</td><td></td></tr> </table> <p>Delete an unprotected record from the memory card.</p>	Data Logging	New	Measurement	Open	Limits	Protect	Probe	Delete	Calibration	Delete All	B-Scan				
Data Logging	New																
Measurement	Open																
Limits	Protect																
Probe	Delete																
Calibration	Delete All																
B-Scan																	
<p>2.</p>	<p>You will see a list of all the records stored on the gauges SD card listed in newest first order.</p> <p>Use the navigation keys to select the record to delete, and then press the ✓ key.</p>	 <p>Select Record to Delete</p> <table border="1"> <tr><td>020315-161425</td><td>Linear</td><td>26</td></tr> <tr><td>MYREC001 1425</td><td>Linear</td><td>0</td></tr> <tr><td>020315-143246</td><td>Linear</td><td>10</td></tr> <tr><td>020315-141355</td><td>Linear</td><td>3</td></tr> <tr><td>020315-125146</td><td>Linear</td><td>10</td></tr> </table> <p>5 Records Found</p>	020315-161425	Linear	26	MYREC001 1425	Linear	0	020315-143246	Linear	10	020315-141355	Linear	3	020315-125146	Linear	10
020315-161425	Linear	26															
MYREC001 1425	Linear	0															
020315-143246	Linear	10															
020315-141355	Linear	3															
020315-125146	Linear	10															
<p>3.</p>	<p>Confirm by pressing the ✓ key.</p>	 <p>Select Record to Delete</p> <table border="1"> <tr><td>020315-161425</td><td>Linear</td><td>26</td></tr> <tr><td>MYREC001 1425</td><td>Linear</td><td>0</td></tr> <tr><td>020315-143246</td><td>Linear</td><td>10</td></tr> <tr><td>020315-141355</td><td>Linear</td><td>3</td></tr> <tr><td>020315-125146</td><td>Linear</td><td>10</td></tr> </table> <p>Delete Record MYREC001 ? Press ✓ or X key</p> <p>5 Records Found</p>	020315-161425	Linear	26	MYREC001 1425	Linear	0	020315-143246	Linear	10	020315-141355	Linear	3	020315-125146	Linear	10
020315-161425	Linear	26															
MYREC001 1425	Linear	0															
020315-143246	Linear	10															
020315-141355	Linear	3															
020315-125146	Linear	10															
<p>4.</p>	<p>The selected record has now been deleted.</p>	 <p>Select Record to Protect</p> <table border="1"> <tr><td>020315-161425</td><td>Linear</td><td>26</td></tr> <tr><td>020315-143246</td><td>Linear</td><td>10</td></tr> <tr><td>020315-141355</td><td>Linear</td><td>3</td></tr> <tr><td>020315-125146</td><td>Linear</td><td>10</td></tr> </table> <p>4 Records Found</p>	020315-161425	Linear	26	020315-143246	Linear	10	020315-141355	Linear	3	020315-125146	Linear	10			
020315-161425	Linear	26															
020315-143246	Linear	10															
020315-141355	Linear	3															
020315-125146	Linear	10															

Deleting All Records

<p>1.</p>	<p>Access the Menu and scroll down to the 'Data Logging' group. Then scroll right and select 'Delete All'.</p> <p>Press the ✓ key to select</p>	 <p>The screenshot shows the 'Main Menu' at 13:45:04. A list of options is shown: Data Logging, Measurement, Limits, Probe, Calibration, and B-Scan. The 'Data Logging' group is expanded, showing sub-options: New, Open, Protect, Delete, and Delete All. 'Delete All' is highlighted with a blue bar. Below the menu, a grey box contains the text: 'Delete all unprotected records from the memory card.'</p>
<p>2.</p>	<p>Confirm by pressing the ✓ key.</p>	 <p>The screenshot shows a yellow dialog box with the text: 'Delete All Unprotected Records?' and 'Press ✓ or X key'.</p>
<p>3.</p>	<p>Confirm again by pressing the ✓ key.</p>	 <p>The screenshot shows a yellow dialog box with the text: 'Confirm Delete All Unprotected Records' and 'Press ✓ or X key'.</p>
<p>4.</p>	<p>All unprotected records will have been deleted from the SD card.</p> <p>A message will inform how many records have been deleted.</p> <p>Continue by pressing the ✓ key.</p>	 <p>The screenshot shows a yellow dialog box with the text: '3 Records Deleted' and 'Press ✓ key to continue'.</p>

Record Status

The Data Logging menu has a Status item at the bottom. This screen will display the status of the current Record.

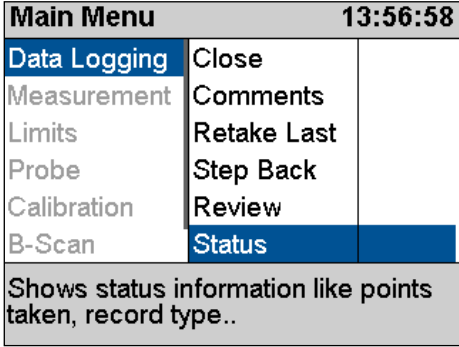
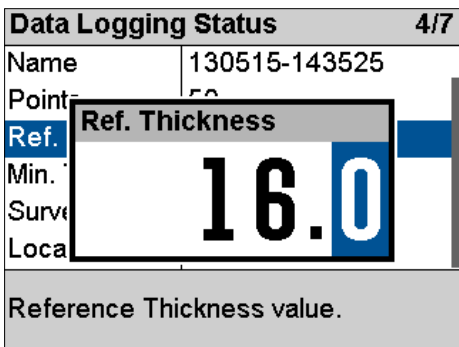
<p>1.</p>	<p>Access the Menu and scroll down to the 'Data Logging' group. Then scroll right and select 'Status'.</p> <p>Press the \checkmark key to select</p>	 <p>Main Menu 13:56:58</p> <table border="1"> <tr> <td>Data Logging</td> <td>Close</td> <td></td> </tr> <tr> <td>Measurement</td> <td>Comments</td> <td></td> </tr> <tr> <td>Limits</td> <td>Retake Last</td> <td></td> </tr> <tr> <td>Probe</td> <td>Step Back</td> <td></td> </tr> <tr> <td>Calibration</td> <td>Review</td> <td></td> </tr> <tr> <td>B-Scan</td> <td>Status</td> <td></td> </tr> </table> <p>Shows status information like points taken, record type..</p>	Data Logging	Close		Measurement	Comments		Limits	Retake Last		Probe	Step Back		Calibration	Review		B-Scan	Status	
Data Logging	Close																			
Measurement	Comments																			
Limits	Retake Last																			
Probe	Step Back																			
Calibration	Review																			
B-Scan	Status																			
<p>2.</p>	<p>Depending on the Record type you will see various items listed.</p> <p>Some items such as Ref Thk and Min Thk can be changed.</p> <p>For Linear Records the number of Points can also be increased.</p>	 <p>Data Logging Status 4/7</p> <table border="1"> <tr> <td>Name</td> <td>130515-143525</td> </tr> <tr> <td>Point</td> <td>50</td> </tr> <tr> <td>Ref.</td> <td>Ref. Thickness</td> </tr> <tr> <td>Min.</td> <td>16.0</td> </tr> <tr> <td>Survey</td> <td></td> </tr> <tr> <td>Local</td> <td></td> </tr> </table> <p>Reference Thickness value.</p>	Name	130515-143525	Point	50	Ref.	Ref. Thickness	Min.	16.0	Survey		Local							
Name	130515-143525																			
Point	50																			
Ref.	Ref. Thickness																			
Min.	16.0																			
Survey																				
Local																				

13. Data Logging Templates

Templates

Templates allow structured data logging of thickness measurements when repeatedly surveying identical or similar objects. A Template is first created using CygLink then the Template is transferred to each Gauge ready for use.

Templates contain the following;

1. A name and description
2. Measurement units and velocity of sound
3. A list of thickness Measurement Points with minimum and reference thicknesses.
4. User Fields (optional)
5. Spreadsheet cell locations (optional)

The user can then create many new data logger Records using a single Template which specifies how the survey is carried out.

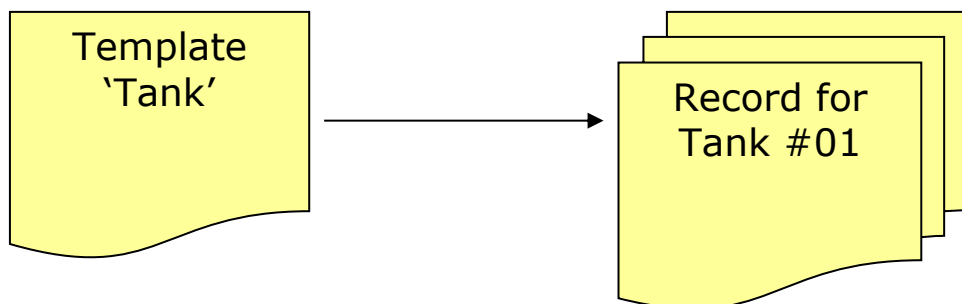

Many Records created from one common Template which specifies content and format.

Integrating with Microsoft Excel

Cygnus offer an Excel Add-In tool that can be used to directly extract the thickness measurement data from the data logger files stored on the SD card in the gauge.

The data in a Record produced from a Template can be inserted into an Excel® Spreadsheet - so each piece of data has an optional destination cell reference – this is the spreadsheet cell the data will be copied into, i.e. cell 'D12'.

An XLT file (Excel® Template) can also be specified to be used as a template for the Excel document produced. So a company report, as an XLT file, can be used to create each new blank report document that will then receive the thickness measurement and other data collected by the Gauge.

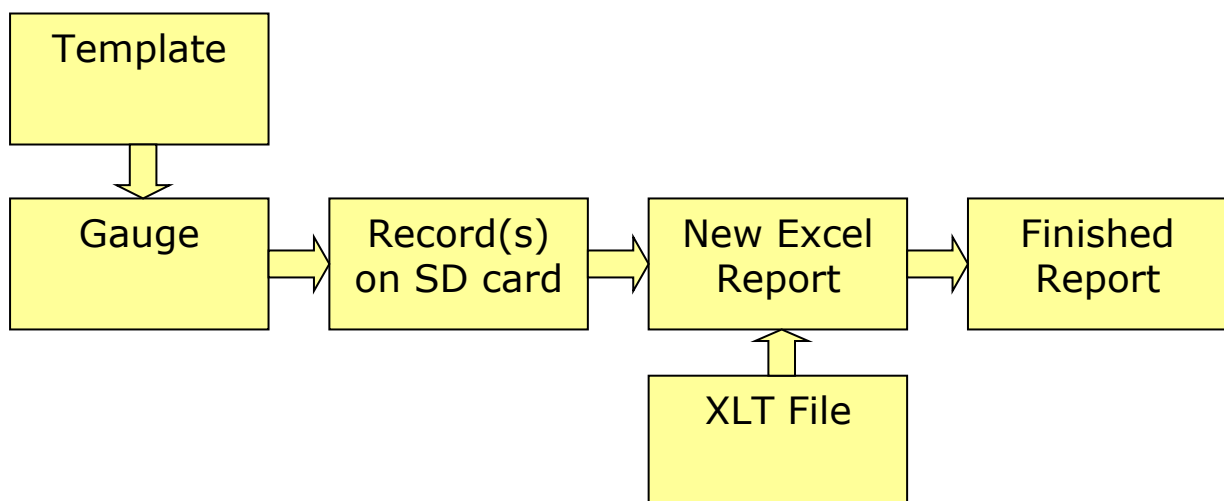

Measurement Points

Templates contain measurement points for each thickness measurement required. Each measurement point consists of a "Name", a "Reference Thickness", a "Minimum Thickness", a "Cell Reference" and the "Thickness Measurement" itself.

The "Reference" and "Minimum Thickness" are optional, but when included they allow wastage calculations in reports and minimum alarm alerts when measuring.

User Fields

Templates can contain up to 40 User Fields which can be used to collect extra information from the Gauge user when they start a new Record from a template.

Each User Field can prompt for the following types of data;

1. **Alphanumeric** i.e. "ABC123"
2. **Number** i.e. "24501"
3. **Date** (dd-mm-yyyy) i.e. "21-07-2008"
4. **List** i.e. "Red, Blue, Yellow, Green.."
5. **Boolean** i.e. "Open" or "Closed"

Each User Field has: a 'Name' field, this is used to prompt the Gauge user to enter in information, and a 'Value' field to hold the information. An optional 'Cell Ref.' field to specify where the Value should be inserted in the spreadsheet.

For example;

*If the User Field Type = Alphanumeric
If the User Field Name = 'Vessel Name'
If the User Field Cell Ref = 'Sheet 1!E20'*

When the Gauge user starts a new record they will be prompted to enter in a 'Vessel Name'.

The vessel name the user types in will be stored against the 'Vessel Name' field and be included in the report data.

As the 'cell ref.' was also specified the vessel name will be inserted into the spreadsheet report into cell 'E20' on 'Sheet 1'.

User Field 'List' Type

When the User Field type is set to List you must provide a list of text choices that will be presented to the gauge user. This list can contain up to 40 items each of 16 characters in length.

14. Manual Gain Adjustment

The gauge will normally operate in automatic gain mode and this will be suitable for virtually every measuring scenario. The automatic gain mode has been designed to find the optimum gain setting during the measurement process and is imperceptible to the operator. It is therefore only recommended to use manual gain mode if you have suitable ultrasonic training and experience and understand the consequences to the measurement if the gain is set incorrectly.

Manual Gain Mode

When the gauge is in manual gain mode the operator can manually adjust either the Gain or A-scan Range using the Up and Down keys during measurement.

The Gain value in dB can be adjusted in 1 dB steps with each ↑ or ↓ key press.



When in manual gain mode the Basic measurement screen is disabled as the A-scan screen should be observed.

Turning on Manual Gain

<p>1. Access the Menu and scroll down to the 'Measurement' group. Then scroll right and select 'Gain Mode'.</p> <p>Press the ✓ key to select</p>	Main Menu 10:03:53																	
	<table border="1" style="width: 100%; border-collapse: collapse;"> <tr> <td style="padding: 2px;">Data Logging</td> <td style="padding: 2px;">Mode</td> <td style="padding: 2px;">SE</td> </tr> <tr> <td style="padding: 2px;">Measurement</td> <td style="padding: 2px;">Gain Mode</td> <td style="padding: 2px;">Auto</td> </tr> <tr> <td style="padding: 2px;">Limits</td> <td style="padding: 2px;">Temp Comp</td> <td style="padding: 2px;">Off</td> </tr> <tr> <td style="padding: 2px;">Probe</td> <td style="padding: 2px;">Resolution</td> <td style="padding: 2px;">0.01</td> </tr> <tr> <td style="padding: 2px;">Calibration</td> <td style="padding: 2px;">Units</td> <td style="padding: 2px;">mm</td> </tr> <tr> <td style="padding: 2px;">Scan</td> <td colspan="2"></td> </tr> </table>	Data Logging	Mode	SE	Measurement	Gain Mode	Auto	Limits	Temp Comp	Off	Probe	Resolution	0.01	Calibration	Units	mm	Scan	
Data Logging	Mode	SE																
Measurement	Gain Mode	Auto																
Limits	Temp Comp	Off																
Probe	Resolution	0.01																
Calibration	Units	mm																
Scan																		
Automatic or Manual gain control using the Up and Down keys																		

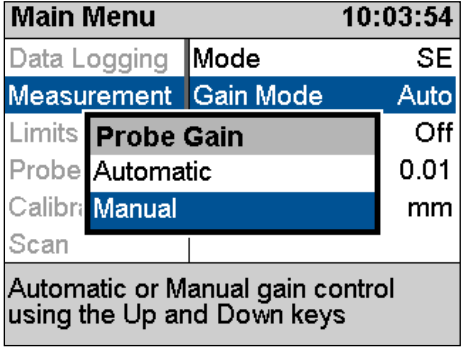
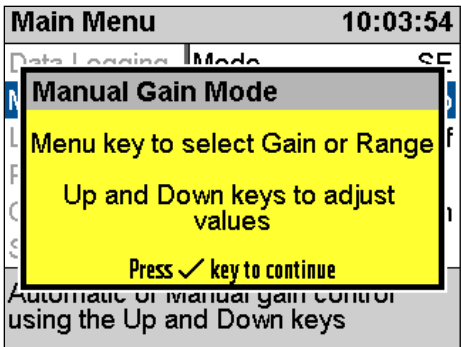
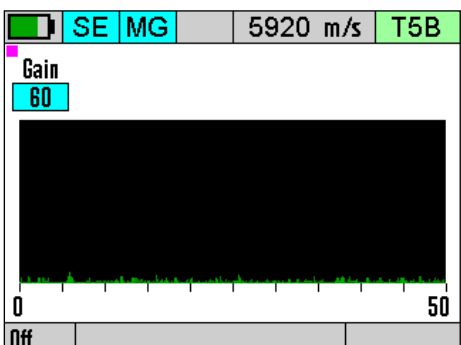
<p>2. Use the ↓ key to select Manual gain mode.</p> <p>Or select Automatic to turn off manual gain mode.</p> <p>Press the ✓ key to select</p>		 <p>Main Menu 10:03:54</p> <table border="1"> <tr> <td>Data Logging</td> <td>Mode</td> <td>SE</td> </tr> <tr> <td>Measurement</td> <td>Gain Mode</td> <td>Auto</td> </tr> <tr> <td>Limits</td> <td>Probe Gain</td> <td>Off</td> </tr> <tr> <td>Probe</td> <td>Automatic</td> <td>0.01</td> </tr> <tr> <td>Calibr</td> <td>Manual</td> <td>mm</td> </tr> <tr> <td>Scan</td> <td></td> <td></td> </tr> </table> <p>Automatic or Manual gain control using the Up and Down keys</p>	Data Logging	Mode	SE	Measurement	Gain Mode	Auto	Limits	Probe Gain	Off	Probe	Automatic	0.01	Calibr	Manual	mm	Scan		
Data Logging	Mode	SE																		
Measurement	Gain Mode	Auto																		
Limits	Probe Gain	Off																		
Probe	Automatic	0.01																		
Calibr	Manual	mm																		
Scan																				
<p>3. When Manual gain mode is selected a message is displayed informing how the Gain or Range is adjusted.</p> <p>Press the ✓ key to continue.</p>		 <p>Main Menu 10:03:54</p> <p>Manual Gain Mode</p> <p>Menu key to select Gain or Range</p> <p>Up and Down keys to adjust values</p> <p>Press ✓ key to continue</p> <p>Automatic or manual gain control using the Up and Down keys</p>																		
<p>4. [MG] is displayed in blue at the top to show Manual Gain mode is active.</p> <p>The Gain setting is shown in blue to show it is active [60]</p>		 <p>SE MG 5920 m/s T5B</p> <p>Gain 60</p> <p>0 50</p> <p>Off</p>																		

Manual Gain Menu

When in manual gain mode a small 'quick menu' is first displayed at the bottom of the screen when the Menu key is pressed, this allows quick selection of Gain, Range or Menu.

A tick is displayed next to Gain or Range to indicate which will be adjusted when the ↑ or ↓ keys are pressed.

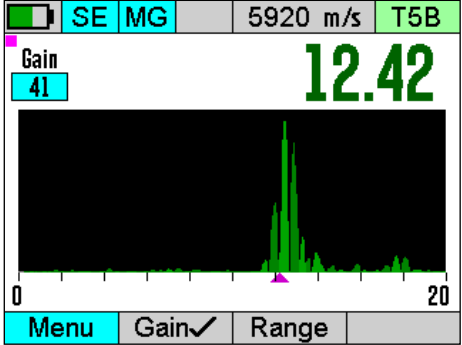
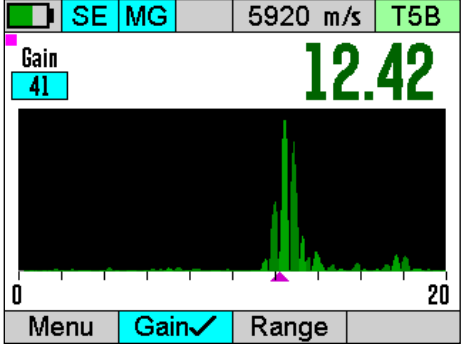
<p>1.</p>	<p>Pressing the Menu key displays the Manual Gain menu as the bottom of the screen.</p> <p>The ✓ shows that Gain adjustment is currently selected.</p>	
<p>2.</p>	<p>Pressing the Menu key again will go straight to the Main Menu as normal.</p>	
<p>3.</p>	<p>Use the Left and Right keys to navigate between Menu, Gain and Range. The selected item will be highlighted in blue.</p> <p>Use the ✓ key to select. Use the X key to cancel.</p>	

Adjusting the Gain

Press the Menu key and check that Gain is ticked – select it if it isn't. Then in the measurement screen with the A-scan displayed use the ↑ or ↓ keys to adjust the gain as required.

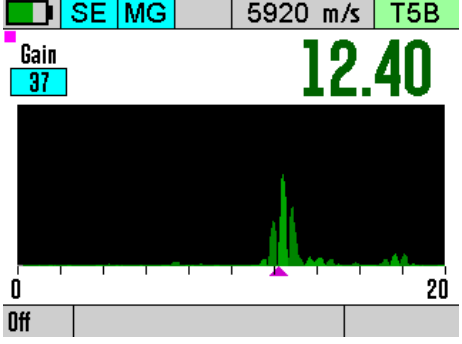
<p>1.</p>	<p>The Gain is set to 37 dB.</p> <p>The A-Scan shows a back wall echo signal around 50% height but there is a thickness value.</p> <p><i>Ideally you would increase the gain to get a 100% high signal.</i></p>	
------------------	---	--

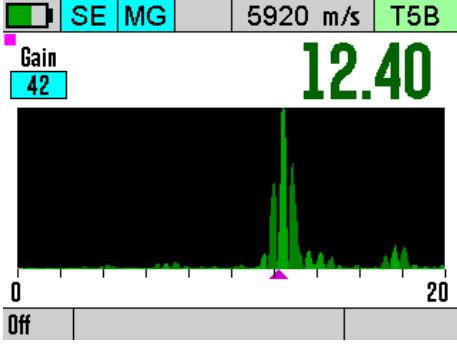
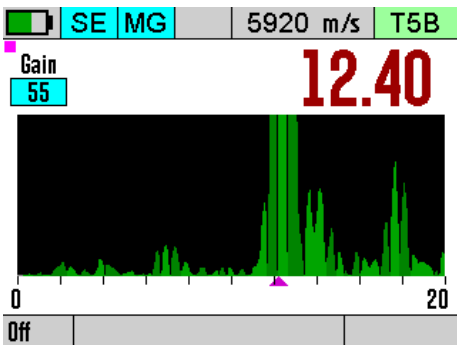
<p>2. The Gain is set to 42 dB.</p> <p>The A-Scan shows a back wall echo signal around 100% height and there is a thickness value.</p> <p><u>This is the optimum setting.</u></p>		
<p>3. The Gain is set to 55 dB.</p> <p>The A-Scan shows a back wall echo signal which goes off the screen, there are also other earlier smaller echoes that are becoming significant. The thickness measurement is still ok however.</p> <p><i>Ideally you would reduce the gain down to get a 100% high signal.</i></p>		

Adjusting the Range

Press the Menu key and check that Range is ticked – select it if it isn't. Then in the measurement screen with the A-scan displayed use the \uparrow or \downarrow keys to adjust the Range as required.

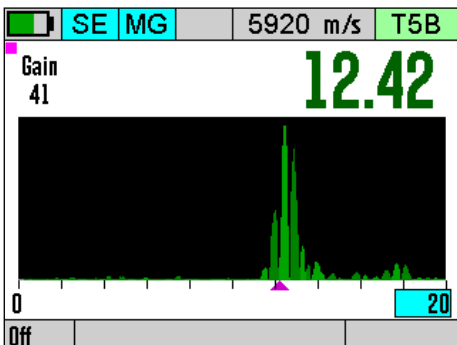
<p>1. When Range is selected the range value is highlighted blue.</p> <p>Here the range is set to 20mm</p> <p>[20]</p>		
---	--	--

2. Use the ↑ or ↓ keys to adjust the value.

Here it's set to 40mm [40]

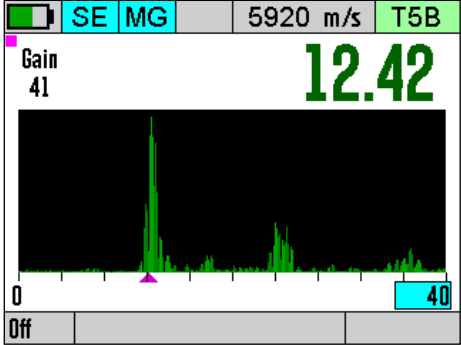

Measuring Below the Probes Minimum Thickness Specification

The minimum thickness measurement specified for the Twin Element probes is valid for when Automatic Gain Mode is selected - this is the default gain mode when the gauge is turned on.

By manually adjusting the gain and observing the A-Scan display it may be possible to measure less than the minimum specified thickness.



This should only be attempted by experienced operators with a good understanding of ultrasound principals.

15. Setup Menu

The Setup group is found at the bottom of the menu, it holds various gauge setup options.

<p>1. Access the Menu and scroll down to the 'Setup' group. Then scroll right to select the required item</p> <p>Press the \checkmark key to open the highlighted item.</p>	Main Menu 16:11:25																	
	<table border="1"> <tr> <td>Measurement</td> <td>A-Scan Range</td> <td>25</td> </tr> <tr> <td>Limits</td> <td>Vibrate</td> <td>Off</td> </tr> <tr> <td>Probe</td> <td>Brightness</td> <td>50%</td> </tr> <tr> <td>Calibration</td> <td>Bluetooth</td> <td>Off</td> </tr> <tr> <td>Scan</td> <td>End Display</td> <td>On</td> </tr> <tr> <td>Setup</td> <td>Rotate</td> <td>No</td> </tr> </table>	Measurement	A-Scan Range	25	Limits	Vibrate	Off	Probe	Brightness	50%	Calibration	Bluetooth	Off	Scan	End Display	On	Setup	Rotate
Measurement	A-Scan Range	25																
Limits	Vibrate	Off																
Probe	Brightness	50%																
Calibration	Bluetooth	Off																
Scan	End Display	On																
Setup	Rotate	No																
Turn the end display On or Off																		

A-Scan Range

The A-Scan range setting sets how the A-Scan X axis scale is set. This can be either Manually or Automatically.

Automatic

When set to Automatic (Auto) the X scale is set using the measured thickness value and the measurement mode. This means when measuring a range of thicknesses the A-Scan range will always be set so you can observe the required number of echoes.

Manual

When set to Manual (Man) you can set the A-Scan range to any value between 5 mm and 1000 mm (0.2" and 39").

Vibrate Feature

The Vibrate feature will vibrate the gauge when a verified thickness measurement is found to alert the user. You can use this menu item to turn this On or Off as required.

Brightness Setting

The display brightness can be set Manually or Automatically using the ambient light level sensor.

- ⚠ Higher brightness will consume more power and so reduce the battery life. To maximise the battery life, choose the lowest brightness that still allows you to read the display.

In Automatic mode the brightness is dimmed when in dark conditions and increased when in bright light conditions.

In Manual mode you can adjust the brightness over 20 levels, 0 is the lowest level.

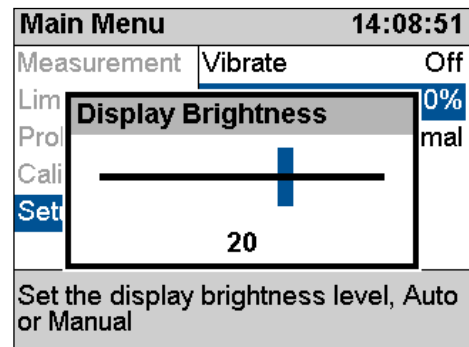

Manual Brightness Setting.

Bluetooth®

The gauge has a Bluetooth module that can be used to connect and pair with a Windows computer so you can transfer Data Logger records and settings wirelessly. The process of pairing the gauge with a computer is simple, once paired the gauge will retain the link information so subsequent connections are automatic.



- ⚠ The Bluetooth module is intended for short range connections (<10 meters), however the actual distance achieved will also depend on the Bluetooth transceiver at the computer end and the environment.

Bluetooth Adapters

If your computer does not have a Bluetooth adapter you will need to source one, generally any Bluetooth 4.0 USB adapter will be suitable. Cygnus recommend Belkin® adapters.

Turning Bluetooth On

By default, the Bluetooth module is turned off to save power, when you want to connect or you must turn Bluetooth on using the Setup menu's Bluetooth item.

 When Bluetooth is turned on the USB port is disabled.

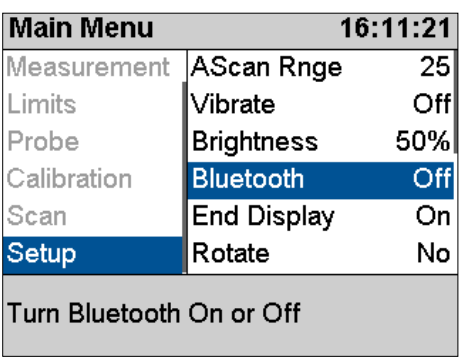
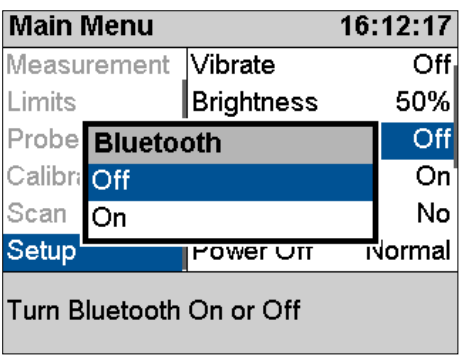
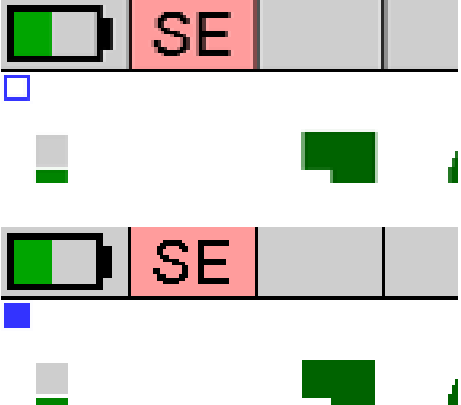
<p>1. Access the Menu and scroll down to the 'Setup' group. Then scroll right to select the 'Bluetooth' item</p> <p>Press the \checkmark key to open the item.</p>		
<p>2. Select On or Off as required.</p> <p>Press the \checkmark key to save your choice.</p>		
<p>3. A Blue box will appear in the measurement screen to show the Bluetooth connection status;</p> <p>Empty box : not connected</p> <p>Solid box : connected</p>		

Pairing with a Computer

This is intended to be a basic overview of how to pair the gauge to a Windows computer. It assumes you have a working Bluetooth module fitted and in range.

Finding the COM Port Assigned

When you use Bluetooth to connect the gauge to the computer you will need to know the COM Port number assigned to the Bluetooth device, you will need to set this COM Port number when using CygLink.

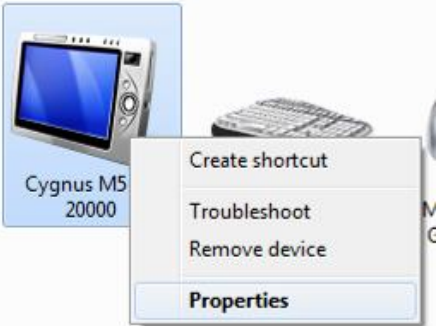
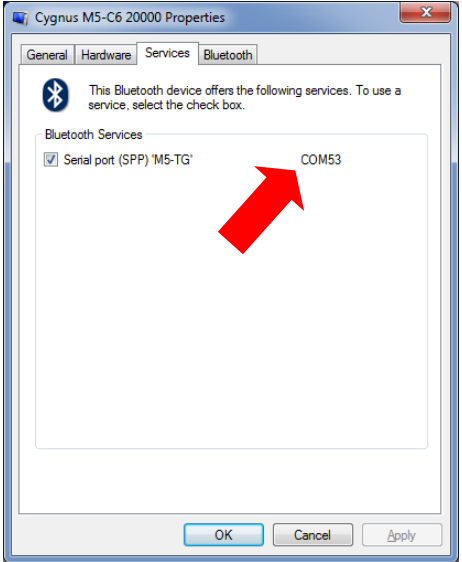
<p>1.</p>	<p>On the gauge turn Bluetooth On. (Assuming it has been paired).</p>	
<p>2.</p>	<p>On the computers start menu type in "View Devices" to find the View Devices and Printers control panel wizard. Start the wizard.</p>	
<p>3.</p>	<p>Click on the 'Cygnus M5-C6' device, then right click and select Properties.</p>	
<p>4.</p>	<p>Click on the Services tab.</p> <p>You should see "Serial port (SPP) 'M5-TG'" listed along with the port number 'COMxx'.</p> <p>'COM20' = COM Port 20</p> <p>Make a note of this COM Port number.</p>	
<p>5.</p>	<p>Close all the Windows' dialog boxes.</p>	

End Display

The End Display can be turned On or Off as required with this setting. Turning off the end display when not required will improve battery life.

Rotate (End Display)

The End Display can be rotated 180 degrees for when the gauge is clipped on to a belt. The Rotate setting will rotate the display 180 degrees when set to Yes.

Power Off Setting

You can choose from three power-saving settings, these determine how long before the gauge will dim the display and ultimately turn off when the gauge is inactive (inactive = no key presses and no thickness measurements).

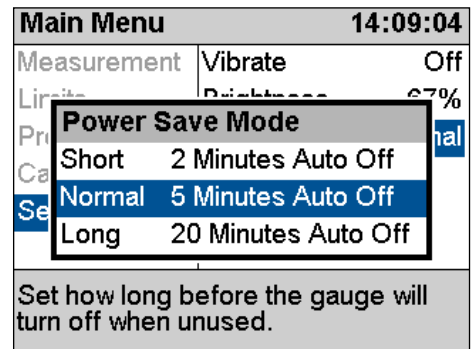

Power Save Modes.

Auto-Log

When Data Logging the Auto-Log feature will automatically 'log' the current thickness measurement when it has been stable for 2 seconds. This setting turns the Auto-Log feature On or Off as required.

Temp Units

The Temperature Compensation feature can have its temperature displayed in °C or °F units. This setting selects either °C or °F units.

Comments

The Data Logger includes a feature where users can select Comments to add to logged thickness measurements, they can

have up to 8 pre-set comments to choose from. This setting allows you to edit the list of Comments.

<p>1. Use the Up and Down keys to select the comment.</p> <p>Press the ✓ key to edit the comment text.</p> <p>Press the X key to save the comments and exit this screen.</p>	<table border="1" style="width: 100%;"> <tr> <th colspan="2" style="text-align: left;">Comment List</th> <th style="text-align: right;">1/8</th> </tr> <tr> <td style="text-align: center;">1</td> <td>Pitting</td> <td></td> </tr> <tr> <td style="text-align: center;">2</td> <td>Corrosion</td> <td></td> </tr> <tr> <td style="text-align: center;">3</td> <td>Delamination</td> <td></td> </tr> <tr> <td style="text-align: center;">4</td> <td>Blistering</td> <td></td> </tr> <tr> <td style="text-align: center;">5</td> <td>Coating Missing</td> <td></td> </tr> <tr> <td style="text-align: center;">6</td> <td>Holed</td> <td></td> </tr> <tr> <td style="text-align: center;">7</td> <td>Repaired</td> <td></td> </tr> <tr> <td colspan="3" style="text-align: center;">Press ✓ key to Edit X key to Exit</td> </tr> </table>	Comment List		1/8	1	Pitting		2	Corrosion		3	Delamination		4	Blistering		5	Coating Missing		6	Holed		7	Repaired		Press ✓ key to Edit X key to Exit		
Comment List		1/8																										
1	Pitting																											
2	Corrosion																											
3	Delamination																											
4	Blistering																											
5	Coating Missing																											
6	Holed																											
7	Repaired																											
Press ✓ key to Edit X key to Exit																												

Set Time and Set Date

These two items allow the user to set the gauges Time and Date. The time and date are used by the Data Logger.

<table border="1" style="width: 100%;"> <tr> <th style="text-align: left;">Main Menu</th> <th style="text-align: right;">14:09:09</th> </tr> <tr> <td>Measurement Vibrate</td> <td style="text-align: right;">Off</td> </tr> <tr> <td>Limit</td> <td style="text-align: right;">37%</td> </tr> <tr> <td>Prob</td> <td style="text-align: right;">ormal</td> </tr> <tr> <td>Calib</td> <td></td> </tr> <tr> <td style="background-color: #0056b3; color: white;">Setu</td> <td></td> </tr> <tr> <td colspan="2" style="text-align: center;"> <table border="1" style="width: 100%;"> <tr> <th colspan="3" style="text-align: left;">Set Time</th> </tr> <tr> <td style="font-size: 2em; font-weight: bold;">14</td> <td style="font-size: 2em; font-weight: bold;">09</td> <td style="font-size: 2em; font-weight: bold;">09</td> </tr> <tr> <td style="text-align: center;">Hour</td> <td style="text-align: center;">Min</td> <td style="text-align: center;">Sec</td> </tr> </table> </td> </tr> <tr> <td colspan="2" style="text-align: center;">Set the Time</td> </tr> </table>	Main Menu	14:09:09	Measurement Vibrate	Off	Limit	37%	Prob	ormal	Calib		Setu		<table border="1" style="width: 100%;"> <tr> <th colspan="3" style="text-align: left;">Set Time</th> </tr> <tr> <td style="font-size: 2em; font-weight: bold;">14</td> <td style="font-size: 2em; font-weight: bold;">09</td> <td style="font-size: 2em; font-weight: bold;">09</td> </tr> <tr> <td style="text-align: center;">Hour</td> <td style="text-align: center;">Min</td> <td style="text-align: center;">Sec</td> </tr> </table>		Set Time			14	09	09	Hour	Min	Sec	Set the Time		<table border="1" style="width: 100%;"> <tr> <th style="text-align: left;">Main Menu</th> <th style="text-align: right;">14:09:20</th> </tr> <tr> <td>Measurement Vibrate</td> <td style="text-align: right;">Off</td> </tr> <tr> <td>Limit</td> <td style="text-align: right;">37%</td> </tr> <tr> <td>Prob</td> <td style="text-align: right;">ormal</td> </tr> <tr> <td>Calib</td> <td></td> </tr> <tr> <td style="background-color: #0056b3; color: white;">Setu</td> <td></td> </tr> <tr> <td colspan="2" style="text-align: center;"> <table border="1" style="width: 100%;"> <tr> <th colspan="3" style="text-align: left;">Set Date</th> </tr> <tr> <td style="font-size: 2em; font-weight: bold;">15</td> <td style="font-size: 2em; font-weight: bold;">01</td> <td style="font-size: 2em; font-weight: bold;">22</td> </tr> <tr> <td style="text-align: center;">Year</td> <td style="text-align: center;">Month</td> <td style="text-align: center;">Day</td> </tr> </table> </td> </tr> <tr> <td colspan="2" style="text-align: center;">Set the Date</td> </tr> </table>	Main Menu	14:09:20	Measurement Vibrate	Off	Limit	37%	Prob	ormal	Calib		Setu		<table border="1" style="width: 100%;"> <tr> <th colspan="3" style="text-align: left;">Set Date</th> </tr> <tr> <td style="font-size: 2em; font-weight: bold;">15</td> <td style="font-size: 2em; font-weight: bold;">01</td> <td style="font-size: 2em; font-weight: bold;">22</td> </tr> <tr> <td style="text-align: center;">Year</td> <td style="text-align: center;">Month</td> <td style="text-align: center;">Day</td> </tr> </table>		Set Date			15	01	22	Year	Month	Day	Set the Date	
Main Menu	14:09:09																																																		
Measurement Vibrate	Off																																																		
Limit	37%																																																		
Prob	ormal																																																		
Calib																																																			
Setu																																																			
<table border="1" style="width: 100%;"> <tr> <th colspan="3" style="text-align: left;">Set Time</th> </tr> <tr> <td style="font-size: 2em; font-weight: bold;">14</td> <td style="font-size: 2em; font-weight: bold;">09</td> <td style="font-size: 2em; font-weight: bold;">09</td> </tr> <tr> <td style="text-align: center;">Hour</td> <td style="text-align: center;">Min</td> <td style="text-align: center;">Sec</td> </tr> </table>		Set Time			14	09	09	Hour	Min	Sec																																									
Set Time																																																			
14	09	09																																																	
Hour	Min	Sec																																																	
Set the Time																																																			
Main Menu	14:09:20																																																		
Measurement Vibrate	Off																																																		
Limit	37%																																																		
Prob	ormal																																																		
Calib																																																			
Setu																																																			
<table border="1" style="width: 100%;"> <tr> <th colspan="3" style="text-align: left;">Set Date</th> </tr> <tr> <td style="font-size: 2em; font-weight: bold;">15</td> <td style="font-size: 2em; font-weight: bold;">01</td> <td style="font-size: 2em; font-weight: bold;">22</td> </tr> <tr> <td style="text-align: center;">Year</td> <td style="text-align: center;">Month</td> <td style="text-align: center;">Day</td> </tr> </table>		Set Date			15	01	22	Year	Month	Day																																									
Set Date																																																			
15	01	22																																																	
Year	Month	Day																																																	
Set the Date																																																			

Set Time and Date Screens.

16. General Points on Thickness Gauging

On very rough surfaces and especially if both sides are badly corroded, it is often necessary to move the probe around to locate a back wall reflector. Sometimes a slight rocking movement can help find reflectors which are otherwise impossible.

Badly corroded sections can also be soaked with a light lubricating oil to improve ultrasound coupling through to the good material.

On heavily corroded steel the use of a Chipping Hammer is recommended to dislodge and loose or delaminated layers, the surface can also be 'prepared' by the action of the hammer's edge removing any uneven surfaces.



A Carbide Scraper can also help to prepare the surface and remove any loose rust or debris.



Good quality hammers and scrapers are available from Cygnus.

Always ensure that there is plenty of couplant present for good contact, but beware that on a pitted surface the Gauge may just measure the couplant-filled pit, always avoid measuring directly over external pits.

Beware that in extreme conditions or if the plate is of poor quality and contains many inclusions the ultrasound will be scattered to such an extent that measurement may not be possible.

Beware that the multiple-echo technique will not work if the front and back surfaces of the material being measured are not close to parallel. Also note that long narrow bars cannot be gauged along their length with the multiple-echo method.

The Gauge should not be used near arc-welding equipment, as this affects its performance.

17. Troubleshooting

The Gauge will not Switch On

- Are the batteries exhausted?
- Check the batteries are inserted correctly.

Difficulty obtaining a Reading

- Check that the Probe lead is properly connected to both Probe and Gauge.
- Check the gauge is set for the probe connected.
- Check the condition of the lead, replace if necessary.
- Check the Probe and its membrane are properly assembled (if a single element probe).
- On heavily corroded areas this is often a problem, try and take measurements in adjacent areas of the same material.
- Check the Gauge and Probe together on a test block, if there is still no reading the Gauge may require servicing.

If Readings are Erratic or Unstable

- Check that the Probe-lead is properly connected to both Probe and Gauge.
- Check that the Probe and its membrane are correctly assembled with sufficient couplant between the probe face and membrane (if a single element probe).
- Check the Probe Type is suitable for the probable minimum thickness of the material being measured. Probe frequencies too low cause doubling and tripling of the actual thickness.

Tips for Optimising Battery Life

- Couplant left on the probe face will stop the gauge entering low power saving mode – so wipe couplant off the probe face between measurement sessions.
- Turning down the backlight brightness will extend battery life.

- Turn Bluetooth off if you are not using it.
- When measuring on very heavily corroded metal with single element probes the gauge uses more power searching for a multiple echo match – this can significantly reduce battery life. So if you are frequently measuring on very heavy corrosion consider using a twin element probe as this will require less power to get measurements.
- Performing a B-Scan will require lots more power than normal thickness measurements as the gauge is taking many more measurements per second, even when the probe is not coupled and scanning – so don't leave the gauge in the B-Scan screen when not scanning.

18. Updating the Gauge

As part of our policy of ongoing development and product improvement Cygnus may issue firmware updates for the gauge. The firmware on the gauge can be easily updated by the user using update software downloaded from the Cygnus website.

Before updating your gauge note the model and serial number of the gauge (see Turning the Gauge On on page 28). You can then check on the Cygnus website if your gauge has the latest firmware version, and if not proceed to download the update software.

You can check for the latest gauge firmware on the Cygnus website [<http://www.cygnus-instruments.com>]. Navigate to **Support** -> **Downloads** -> **Technical Software** and look for a PDF document called 'M5 Surface Gauge Firmware Version Info' view this document to find the latest version for your gauge along with any changes made. *Note you will need to create an account to access this section of the website.*

Update the Firmware

To update a gauge you must first download and install the 'Cygnus M5 Surface Gauge Updater' software. This is available from the Cygnus website in the **Support** -> **Downloads** -> **Technical Software** section. There is a PDF document with instructions available.

Gauge Firmware Files

You must download the appropriate Gauge Firmware file for the model of gauge, i.e., M5-SG-Vxxx-EN

Once downloaded the gauge can be easily updated via the USB cable connecting the gauge to the computer. The whole process takes about 2 minutes. There is a PDF document with detailed instructions available on the website.

Upgrading the Gauge Model

You can easily upgrade a gauge model to enable more features, this is done by ordering an upgrade code from Cygnus instruments. You will need to quote the serial number of the gauge you wish to upgrade, as each upgrade code is unique for that gauge. Cygnus will then send you the upgrade code.

Entering the Upgrade Code

The Upgrade Code is entered in the Factory Menu, follow these steps to upgrade a gauge.

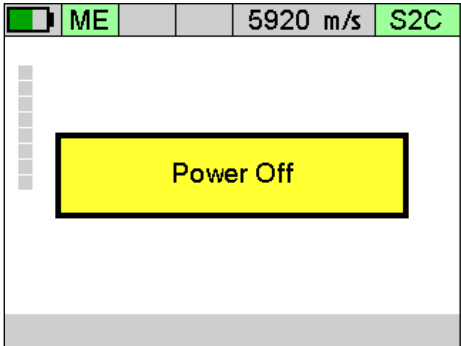
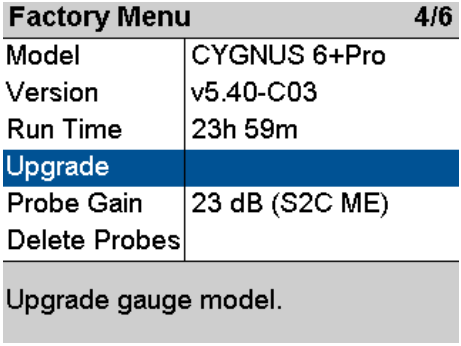
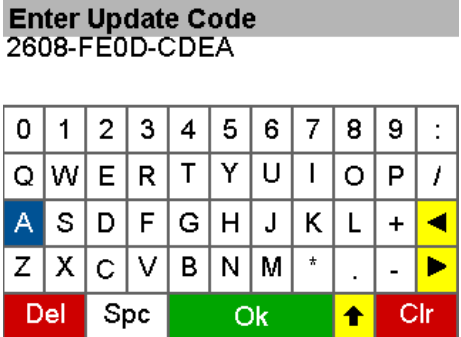
<p>1.</p>	<p>With the gauge turned on, press the Power key to turn off the gauge.</p> <p>Then as soon as you see the Power Off message press and hold the Menu key</p>	
<p>2.</p>	<p>After 5 seconds the Factory Menu is displayed.</p> <p>Scroll down to the Upgrade item and press the ✓ key.</p>	
<p>3.</p>	<p>Enter the update code exactly as it appears, then select the Ok screen key, then press the ✓ key to input the code.</p> <p><i>See Inputting Text using the Navigation Keys on page 55</i></p>	

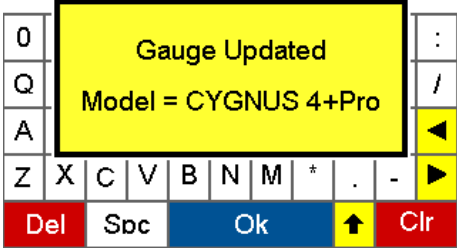
<p>4. If the update code is validated, a Gauge Updated message is displayed showing what model the gauge has been updated to.</p> <p>The gauge will now re-boot.</p>	<div style="border: 1px solid black; padding: 5px;"> <p>Enter Update Code 2608-FE0D-CDEA</p> </div> 
---	---

19. Care and Servicing

Cleaning the Gauge

- ✓ Clean the Gauge and accessories with a damp cloth. Use water with a mild detergent household cleaner.
- ✗ Do not use solvents to clean the Gauge.
- ✗ Do not use any abrasive cleaner, especially on the display window.
- ✗ Do not immerse the Gauge in liquid when cleaning.

Batteries

- ✓ Always remove the batteries if the Gauge will not be used for more than a few days.
- ✓ Only use leak-proof batteries, Cygnus recommend Duracell batteries.

Environmental

- ✗ Do not immerse the Gauge in liquids. The gauge is designed to be IP67 but it is not intended for use in water.
- ✗ Do not subject the Gauge to temperatures greater than 50°C (122°F).
- ✗ Do not store the Gauge for long periods in conditions of high humidity.

Repairs

- ✗ There are no user serviceable parts inside the Gauge. Therefore all repair work should be carried out by Cygnus Instruments or by an Authorised Cygnus Service dealer.

Returning the Gauge for Servicing

A full Manufacturer's Factory Service is available from Cygnus Instruments.



The Complete Kit should always be returned for Service or Repair, including all Probes and Leads.

Cygnus Gauges are renowned for their reliability, very often problems with getting measurements are simply due to the way the Gauge is being used.

However, if you do need to return you're Gauge for Repair please let us know the details of the problem, to help us guarantee the best possible service:

- Is the problem Intermittent Behaviour?
- Is there a problem turning the Gauge On?
Or a problem with the Gauge turning itself Off?
- Does the Gauge constantly give Incorrect Readings, or Unsteady Readings?
- Is it not possible to Calibrate the Gauge?

20. CygLink Computer Software

CygLink V5 is a Windows® program that is used to transfer Data Logger records from the gauge so they can be inspected, edited and reports produced. CygLink offers the following features;

- Create a Survey to contain your data logged records and measurements
- Transfer your data logged records and B-Scans from the gauge
- Organise your records and measurement points
- View A-Scan graphs
- View B-Scan graphs
- Add comments to individual measurement points
- Create a PDF report of a survey
- Export data from the survey to a CSV⁴ file
- Create and manage Templates

Data is transferred using the USB port on the gauge (under the battery cover) using a standard USB Mini B lead supplied in the kit, or by Bluetooth for wireless connectivity.



USB Port Location

USB Mini B Lead

⁴ CSV (Comma Spaced Variable) for opening in a spreadsheet like Microsoft Excel.

Installing CygLink

CygLink V5 is supplied with the kit on a USB Flash Drive, or it can be downloaded from the Cygnus Instruments website. If you want to make sure you are installing the latest version then downloading from the website is the best route.

Requirements

To install and run CygLink the computer must:

1. Be running Windows 10 or a newer version
2. Have sufficient resources for Microsoft .NET Framework installation
3. We recommend a screen resolution of 1280 x 720 or greater
4. We recommend at least 1GB of memory

Upgrading

You can check the Cygnus Instruments website for the latest version of CygLink V5.



If you are upgrading from an older version of CygLink then you must uninstall the old version of CygLink first.

Installing

If you downloaded the CygLink installer file from the Cygnus website then this is a single self-extracting ZIP file.

Double click the 'setup' or 'CygLink...' exe file to start installation. You will need to agree to the license terms and conditions. There are no options to select so installation is straight forward.

Connecting to the Gauge

First time USB Connection

When you first connect the gauge to the computers USB port Windows will search for a suitable driver, you may notice this message from the taskbar;

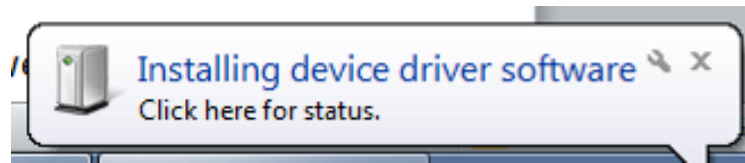

If you click the message you should see the driver installation process;

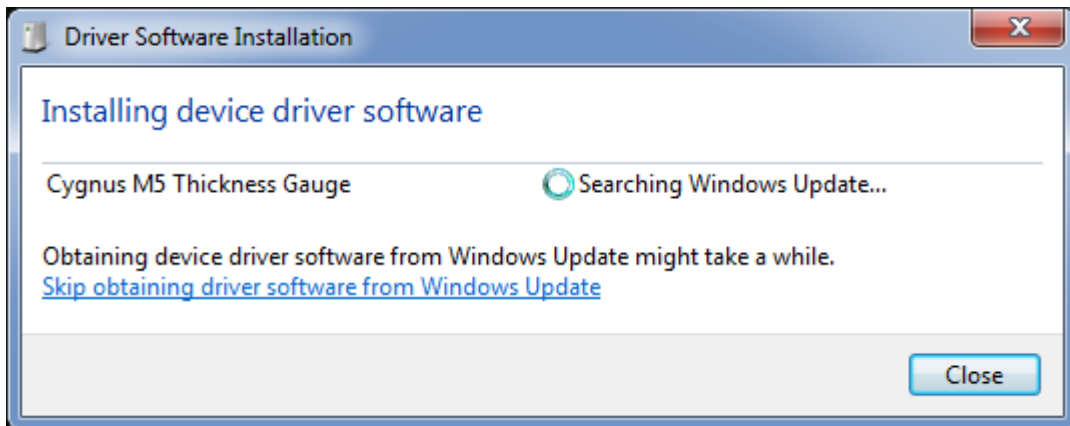

You can 'Skip' this process, but otherwise let it proceed and eventually you should see the following message;

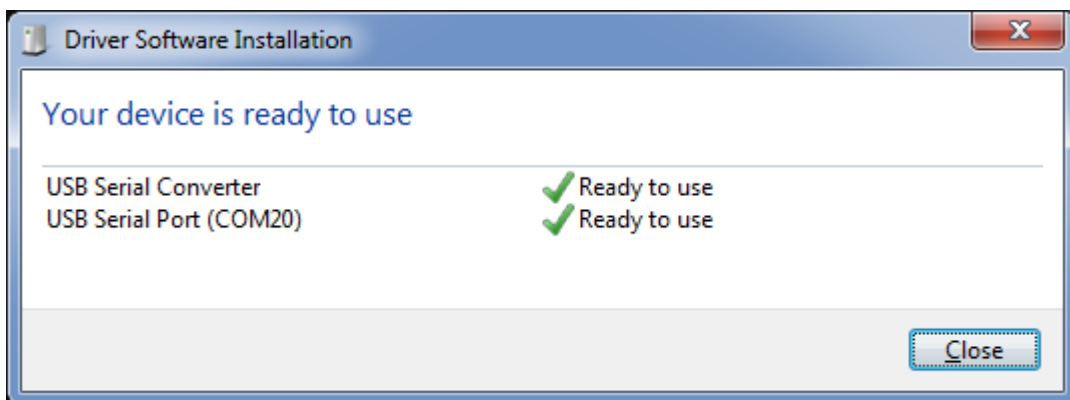

Connecting the Gauge to CygLink for the First Time

- | | | |
|-----------|-------------------|--|
| 1. | Turn on the gauge | |
|-----------|-------------------|--|

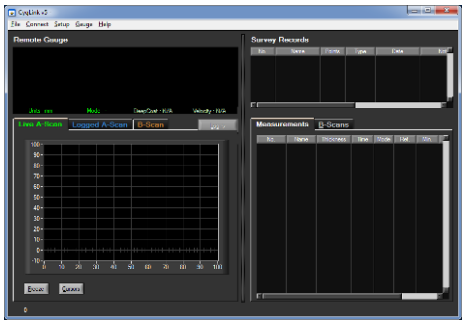
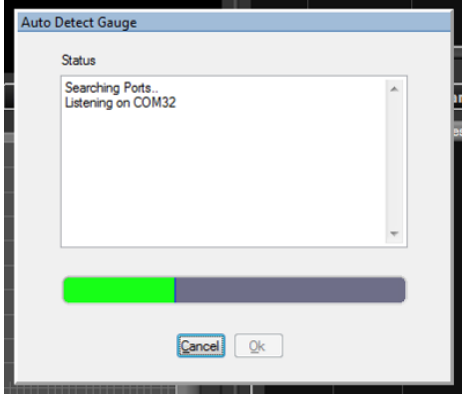
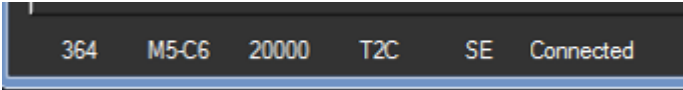
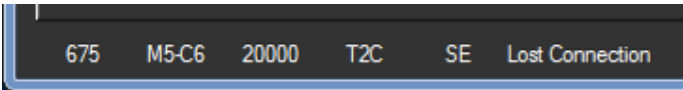
<p>2.</p>	<p>Run CygLink V5</p>	
<p>3.</p>	<p>From the Menu click; Connect ↳ Discover new Gauge and Connect</p>	
<p>4.</p>	<p>CygLink will search all the available Com ports listening for a Cygnus gauge..</p> <p>If a gauge is detected then it will connect and save these settings for next time.</p>	
<p>5.</p>	<p>When connected you should see details of the gauge in the status bar at the bottom and 'Connected'</p>	
		
<p>6.</p>	<p>If the connection is ever lost the status bar will show 'Lost Connection'</p>	
		

Connecting using Bluetooth

The Cygnus 6+ model has a Bluetooth connection option. To use a Bluetooth connection with CygLink connect using the **Discover new Gauge and Connect** menu option and CygLink should locate the Bluetooth Com port if connected.

To pair a gauge to the computer, see Pairing with a Computer on page 111.

Connecting to the Gauge Afterwards

<p>1.</p>	<p>Once you have discovered the Gauge the connection settings will be stored for next time, so to connect next time click from the menu;</p> <p>Connect ↳ Connect to M5-C6 Gauge</p>	
------------------	---	--

Disconnecting from the Gauge

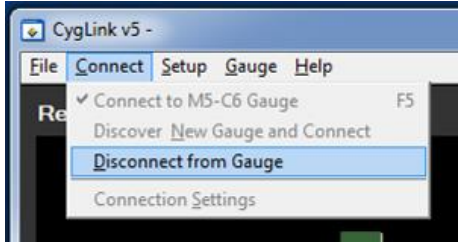
<p>1.</p>	<p>To disconnect from the Gauge click from the menu;</p> <p>Connect ↳ Disconnect from Gauge</p>	
------------------	--	---

Manual Connection Settings

If you need to manually set the connection settings then select the **Connection Settings** option from the **Connect** menu, here you can specify the COM Port number, gauge type and baud rate.

Status Bar

At the bottom of the CygLink screen is the Status Bar, it shows information about the gauge and the connection.



Status Bar

From left to right;

1. Received message counter (increase as message arrive from the gauge)
2. The Gauge Model number
3. The gauge’s serial number

4. The probe type connected to the gauge
5. The gauge's measurement mode
6. The connection state (Connected, Lost Connection, Disconnected)
7. The gauge's battery level

Surveys

A Survey is a container for all your data logger records and measurements. A Survey can be saved to a single file which can be copied or send electronically to another CygLink user. The Survey file is binary and cannot be tampered with.

Creating a new Survey

You don't have to create a Survey but it does create the container for any records that you transfer from the gauge. If you intend to save the records transferred then you will need to create a survey file anyway.

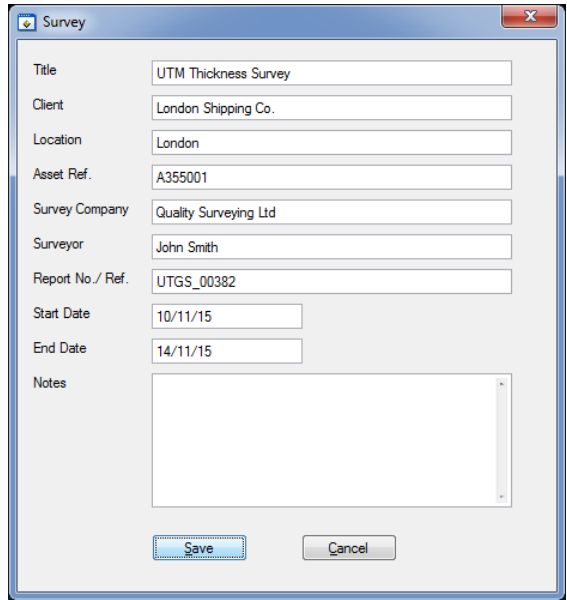
<p>1. From the Menu click; File ↳ New Survey</p>	
<p>2. Complete as many fields as required, you can always go back and edit this information.</p> <p>This information will appear on the PDF report and the export to CSV file output.</p>	 <p>The screenshot shows a 'Survey' dialog box with the following fields and values:</p> <ul style="list-style-type: none"> Title: UTM Thickness Survey Client: London Shipping Co. Location: London Asset Ref.: A355001 Survey Company: Quality Surveying Ltd Surveyor: John Smith Report No./Ref.: UTGS_00382 Start Date: 10/11/15 End Date: 14/11/15 Notes: (Empty text area) <p>Buttons: Save (highlighted), Cancel</p>

- 3.** You can save your new Survey to a file, from the Menu click;

File

- └ **Save Survey**

Entering your filename and location.

Opening an Existing Survey

- 1.** From the Menu click;

File

- └ **Open Survey**

- 2.** You may be prompted to save any unsaved data first

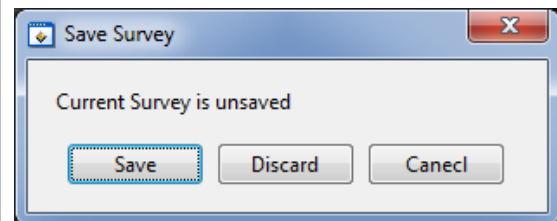

Editing the Survey Info

- 1.** From the Menu click;

File

- └ **Edit Survey Info**

Managing the Survey

Sorting Survey Records

You can sort some of the columns in the Survey Records list by clicking on the column header. A column that has been sorted is marked with an asterisk after the column name. Clicking the column header a second time will toggle between an ascending or descending sort.

No.	Name	Points*	Type	Date	Notes	State	Gauge	S/No	Title
1	091215-110546	35	Grid 2D	09-Dec-15 11:05		Open	M5-C6	20000	
2	091215-095752	30	Linear	09-Dec-15 09:57		Open	M5-C6	20000	
3	091215-135853	30	Grid 2D	09-Dec-15 13:58		Open	M5-C6	20000	
4	091215-125403	20	Template	09-Dec-15 12:54		Open	M5-C6	20000	T20_UF
5	091215-134513	0	Linear	09-Dec-15 13:45		Open	M5-C6	20000	

Survey Records List

Survey list columns that can be sorted;

- Name (ascending or descending)
- Points (ascending or descending)
- Type
- Date (ascending or descending)

Viewing Record Information

You can view the details of a record by right-clicking on the record in the list which will display a context menu, select the Properties item.

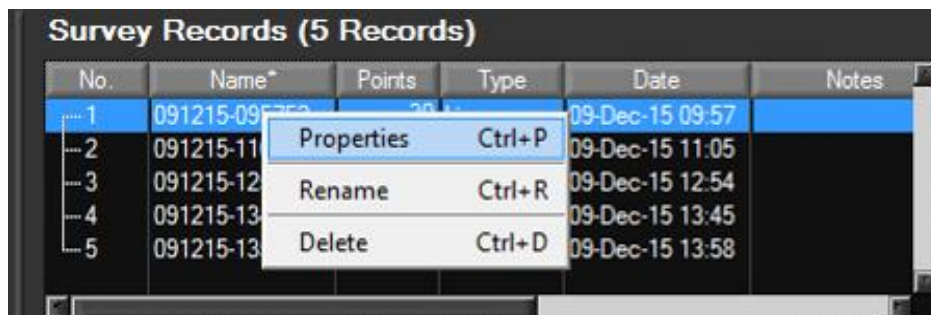

Record Properties Screen

The Record Properties will be displayed;

Record

Name: 091215-095752

Title:

Comment:

Location: Cygnus

Surveyor: David

Notes:

Ref. Thickness: 16.00

Min. Thickness: 14.00

Protection State: Open

Details

Date	09-Dec-15 09:57
Gauge Type	M5-C6
Gauge ID	1
Serial No	20000
Record Type	Linear
Title	
Units	mm
Source	Gauge

Record Properties Screen

You can edit the fields in this screen, the **Details** table is read only and contains details about the record and summary information about its measurements.

Ref and Min Thickness

You can set and apply a Reference and Minimum thickness value for the record, click the **Apply..** button to apply this values to the measurement points in the record.

Protection State

You can set a record to be Protected or Open, when Protected it will prevent users from editing the measurement points or deleting them.

Measurement Summary Stats

If you scroll down the **Details** table you will see summary information about the measurements contained in the records;

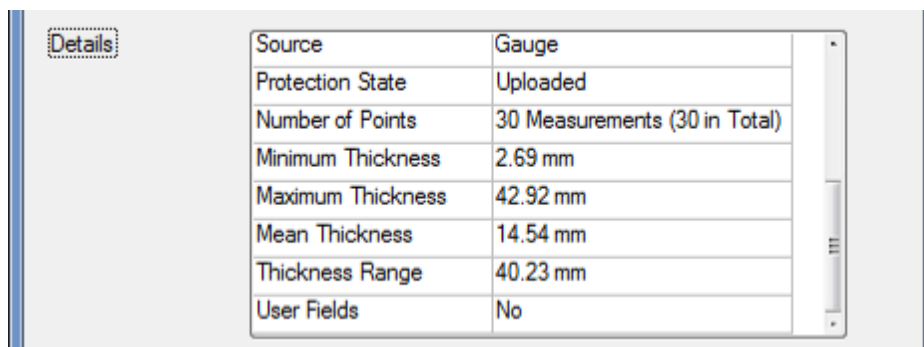

Source	Gauge
Protection State	Uploaded
Number of Points	30 Measurements (30 in Total)
Minimum Thickness	2.69 mm
Maximum Thickness	42.92 mm
Mean Thickness	14.54 mm
Thickness Range	40.23 mm
User Fields	No

Record Properties Screen - Stats

2. This information will appear on the PDF report and the export to CSV file output.

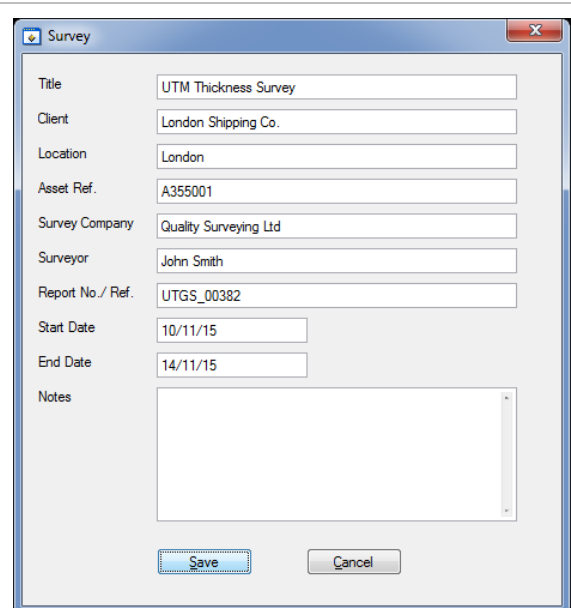

Title	UTM Thickness Survey
Client	London Shipping Co.
Location	London
Asset Ref.	A355001
Survey Company	Quality Surveying Ltd
Surveyor	John Smith
Report No./ Ref.	UTGS_00382
Start Date	10/11/15
End Date	14/11/15
Notes	

Save Cancel

Data Logger Records

Transferring Records from the Gauge

You need to be connected to the gauge to transfer records.

- 1.** From the Menu click;
Gauge
 ↳ **Transfer Records from Gauge**
- 2.** A list of records stored on the gauge will be displayed. You can select the individual record you wish to transfer, or click **Select All**.

If you check **Delete records after Transfer** they will be deleted from the gauges memory card after transferring.

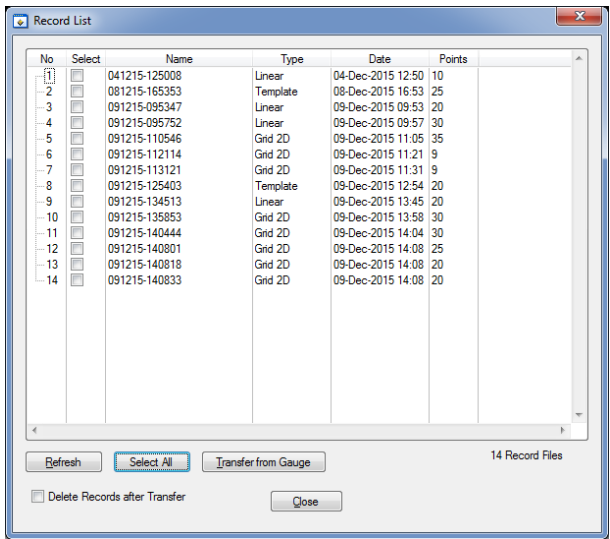
- 3.** To start the transfer click **Transfer from Gauge**

Click **Transfer** to confirm..

During the transfer process a progress screen is displayed

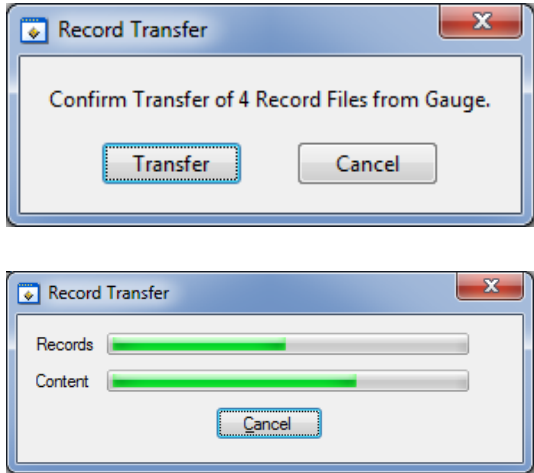
- 4.** When all the records have been transferred they will be listed in the **Survey Records** list

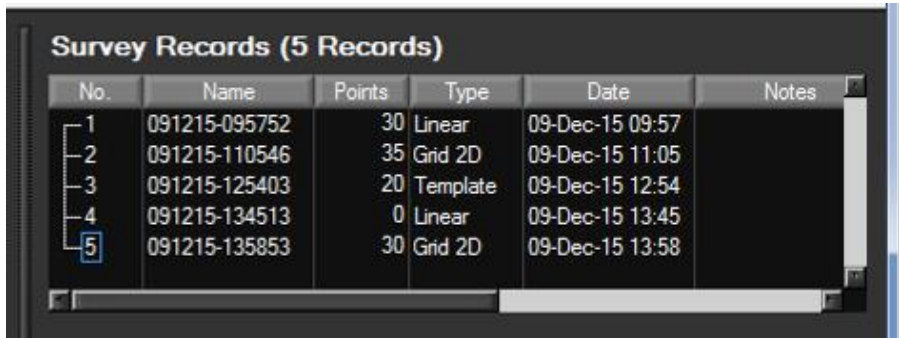

- 5.** You should save the Survey file now, from the Menu click;
File
 L **Save Survey**

Viewing Thickness Measurements in a Record

To display the list of thickness measurements in a record click on the record in the **Survey Records** list, the **Measurements** tab below will display the measurements belonging to the record;

Survey Records (5 Records)					
No.	Name*	Points	Type	Date	Notes
1	091215-095752	30	Linear	09-Dec-15 09:57	
2	091215-110546	35	Grid 2D	09-Dec-15 11:05	
3	091215-125403	20	Template	09-Dec-15 12:54	
4	091215-134513	0	Linear	09-Dec-15 13:45	
5	091215-135853	30	Grid 2D	09-Dec-15 13:58	

Measurements (30)							B-Scans (0)
No.	Name	Thickness	Time	Mode	Ref.	Min.	C
1	P1	14.00	09:58	SE	16.00	14.00	
2	P2	15.09	09:58	SE	16.00	14.00	
3	P3	14.54	09:58	SE	16.00	14.00	
4	P4	13.81	09:58	SE	16.00	14.00	
5	P5	13.63	09:58	SE	16.00	14.00	
6	P6	13.36	09:58	SE	16.00	14.00	
7	P7	13.17	09:58	SE	16.00	14.00	
8	P8	12.90	09:58	SE	16.00	14.00	
9	P9	14.16	09:58	SE	16.00	14.00	
10	P10	14.15	09:58	SE	16.00	14.00	
11	P11	13.21	09:58	SE	16.00	14.00	
12	P12	13.21	09:58	SE	16.00	14.00	
13	P13	14.25	09:58	SE	16.00	14.00	
14	P14	14.22	09:58	SE	16.00	14.00	
15	P15	14.02	09:58	SE	16.00	14.00	
16	P16	42.92	09:58	SE	16.00	14.00	
17	P17	13.60	09:58	SE	16.00	14.00	
18	P18	11.80	09:58	SE	16.00	14.00	
19	P19	12.16	09:58	SE	16.00	14.00	

Record and Measurements Tab

Managing Measurements

You can right-click a selected measurement to display the context-menu;

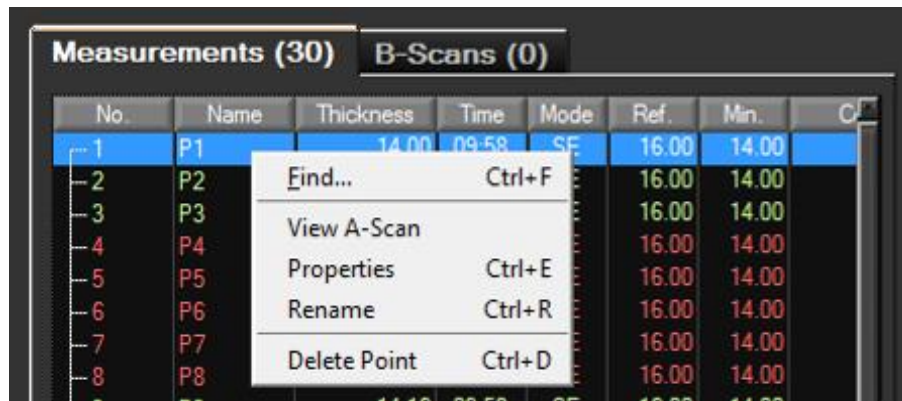

Measurements Context Menu

This menu allows you to **Find**, **Rename** and **Delete** a measurement point, you can also view information about the measurement or display it's **A-Scan** graph if it has one.

 Note there is no undo function - once deleted the measurement point is lost, unless you have saved a copy of the survey or the record is still saved on the gauge.

Viewing Measurement Information

Clicking Properties from the context menu will display the measurement properties screen;

Point Type	Normal
Source	Gauge
Date	09-Dec-15 09:58
Thickness	14.00 mm
Units	mm
Measurement Mode	Single Echo
Resolution	High
Velocity	5920
Deep Coat	Off
Temp. Comp.	Non
Probe Type	T5B
Has A-Scan	Yes
Gain	35 dB

Measurements Properties Screen

Adding Comments to Measurements

You can add comments to a measurement point using the measurement properties screen. The **Notes** field can be directly typed into or you can click the **Add From Comments** button to select a comment from the pre-defined list.

Comments will appear next to the measurement in the PDF report.

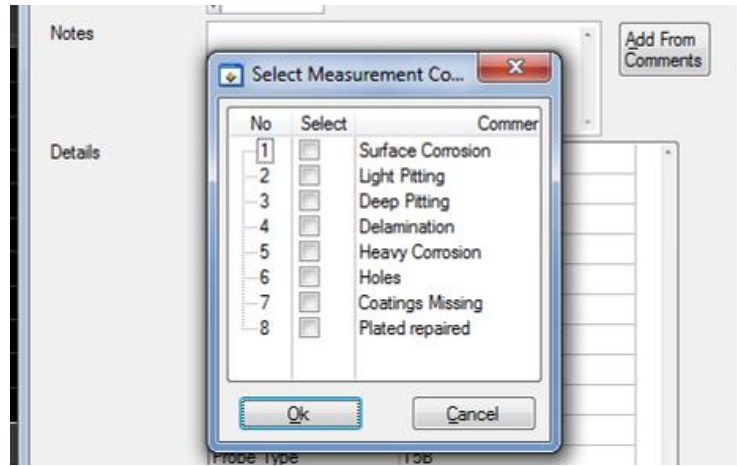

Selecting Measurements Comments from the List

Just select the required comments in the list and click **Ok**.

Viewing an A-Scan Graph

You can select the **View A-Scan** item from the measurements context menu or double click the measurement row. The A-Scan graph will be displayed in the **Logged A-Scan** tab section on the left.

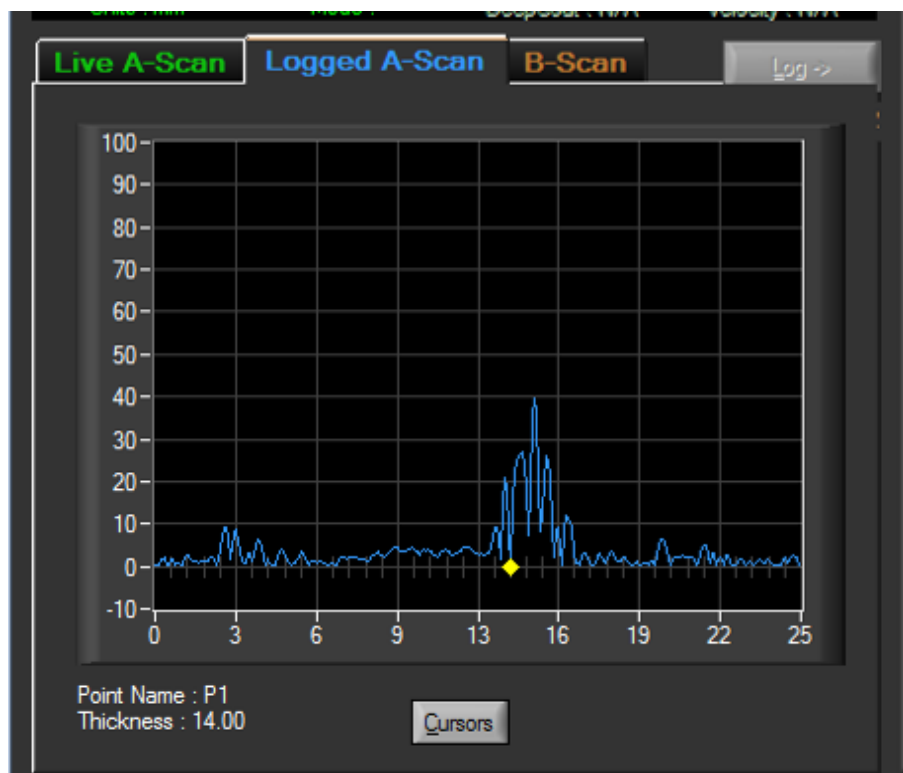

Logged A-Scan Graph

You can toggle the measurement cursors on and off by clicking the **Cursors** button;

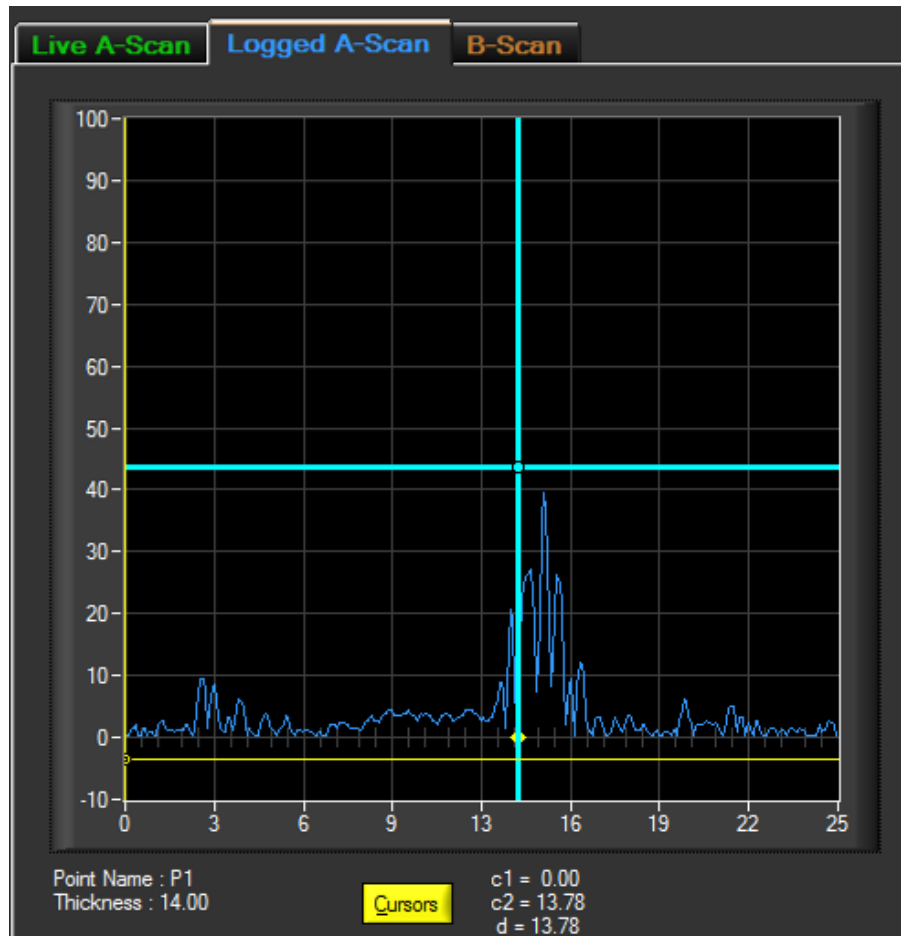

Logged A-Scan Graph with Measurement Cursors

The thickness values of the two cursors (c1 = yellow, c2 = blue) are displayed to the right of the Cursor button along with the difference between the two cursors for relative measurements (d).

Deleting all Records from the Gauge

After you have transferred your records from the gauge in to the Survey and saved the survey file you can delete these records from the gauges SD card so the gauge is 'clean' and ready for new records to be created.

- 1.** From the Menu click;
Gauge
└ **Delete All Records in Gauge**

2. When successful the gauge will show a "Records Deleted" message on its display.



B-Scans

Transferring B-Scans from the Gauge

You can transfer selected B-Scan files from the gauge and add to the Survey, these B-Scans can also be included in the Survey PDF report.

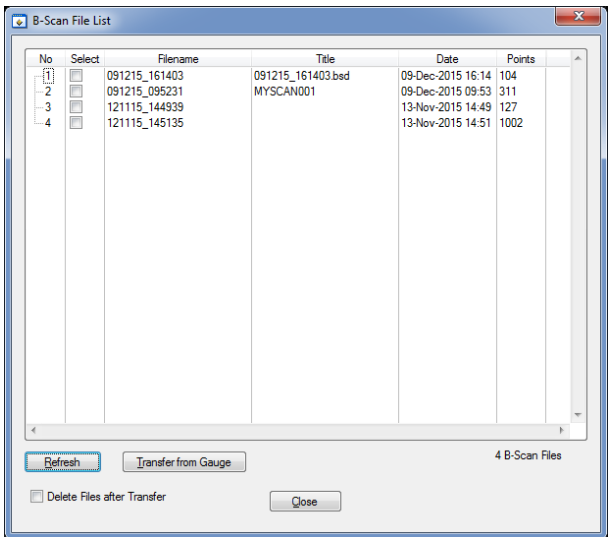
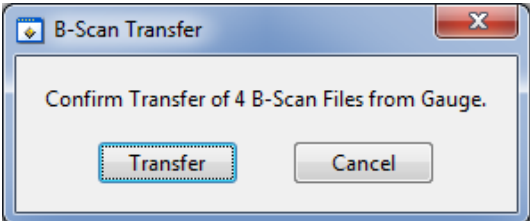
 Note. Because B-Scan files can be large in size transferring many large B-Scans will take a significant time. It is also not recommended to use Bluetooth to transfer large number of B-Scan files as this is slower than the USB connection.

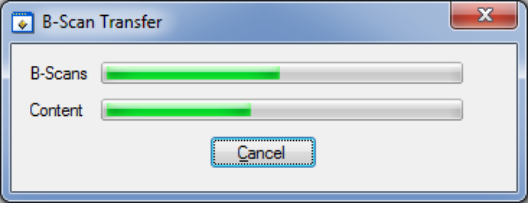
<ol style="list-style-type: none"> 1. 	<p>From the Menu click; Gauge └ Transfer B-Scan from Gauge</p>																															
<ol style="list-style-type: none"> 2. 	<p>A list of B-Scans stored on the gauge will be displayed. You must select the individual record you wish to transfer.</p> <p>If you check Delete Files after Transfer they will be deleted from the gauges memory card after transferring.</p>	 <table border="1"> <thead> <tr> <th>No</th> <th>Select</th> <th>Filename</th> <th>Title</th> <th>Date</th> <th>Points</th> </tr> </thead> <tbody> <tr> <td>1</td> <td><input checked="" type="checkbox"/></td> <td>091215_161403</td> <td>091215_161403.bsd</td> <td>09-Dec-2015 16:14</td> <td>104</td> </tr> <tr> <td>2</td> <td><input type="checkbox"/></td> <td>091215_095231</td> <td>MYSCAN001</td> <td>09-Dec-2015 09:53</td> <td>311</td> </tr> <tr> <td>3</td> <td><input type="checkbox"/></td> <td>121115_144939</td> <td></td> <td>13-Nov-2015 14:49</td> <td>127</td> </tr> <tr> <td>4</td> <td><input type="checkbox"/></td> <td>121115_145135</td> <td></td> <td>13-Nov-2015 14:51</td> <td>1002</td> </tr> </tbody> </table>	No	Select	Filename	Title	Date	Points	1	<input checked="" type="checkbox"/>	091215_161403	091215_161403.bsd	09-Dec-2015 16:14	104	2	<input type="checkbox"/>	091215_095231	MYSCAN001	09-Dec-2015 09:53	311	3	<input type="checkbox"/>	121115_144939		13-Nov-2015 14:49	127	4	<input type="checkbox"/>	121115_145135		13-Nov-2015 14:51	1002
No	Select	Filename	Title	Date	Points																											
1	<input checked="" type="checkbox"/>	091215_161403	091215_161403.bsd	09-Dec-2015 16:14	104																											
2	<input type="checkbox"/>	091215_095231	MYSCAN001	09-Dec-2015 09:53	311																											
3	<input type="checkbox"/>	121115_144939		13-Nov-2015 14:49	127																											
4	<input type="checkbox"/>	121115_145135		13-Nov-2015 14:51	1002																											
<ol style="list-style-type: none"> 3. 	<p>To start the transfer click Transfer from Gauge</p> <p>Click Transfer to confirm..</p>																															

	<p>During the transfer process a progress screen is displayed</p>	
<p>4.</p>	<p>When all the B-Scans have been transferred they will be listed in the B-Scan list tab</p>	
<p>5.</p>	<p>You should save the Survey file now, from the Menu click; File └ Save Survey</p>	

B-Scan Menu

You can right-click a selected B-Scan in the list to display the context-menu;

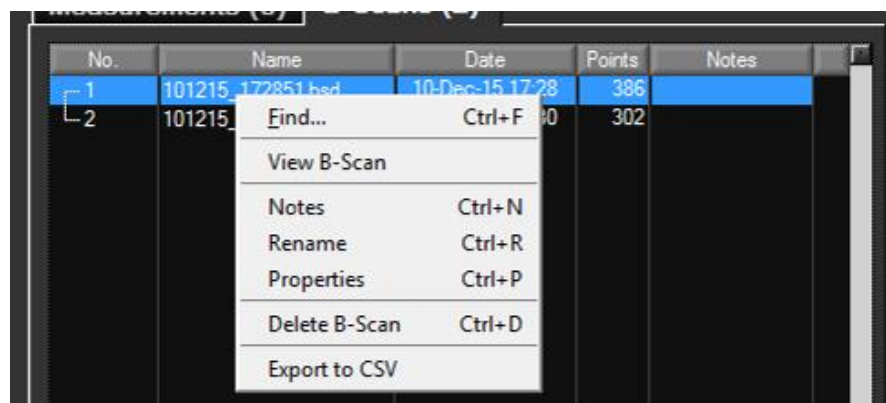

B-Scan List Context Menu

You can add **Notes** to the B-Scan, **Rename** it, **Delete** it or **Export** the Data to a CSV file.

Viewing a B-Scan Graph

You can select the **View B-Scan** item from the B-Scan context menu or double click the B-Scan row. The B-Scan graph will be displayed in the **B-Scan** tab section on the left.

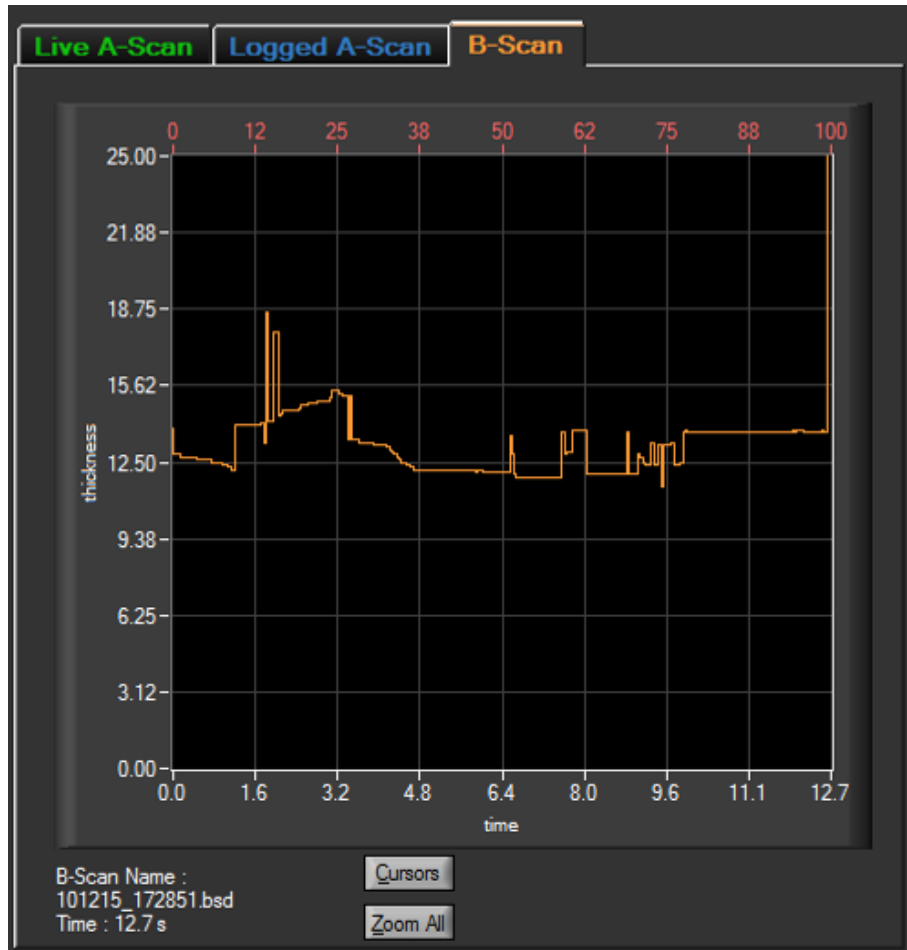

B-Scan Graph

You can toggle the measurement cursors on and off by clicking the **Cursors** button;

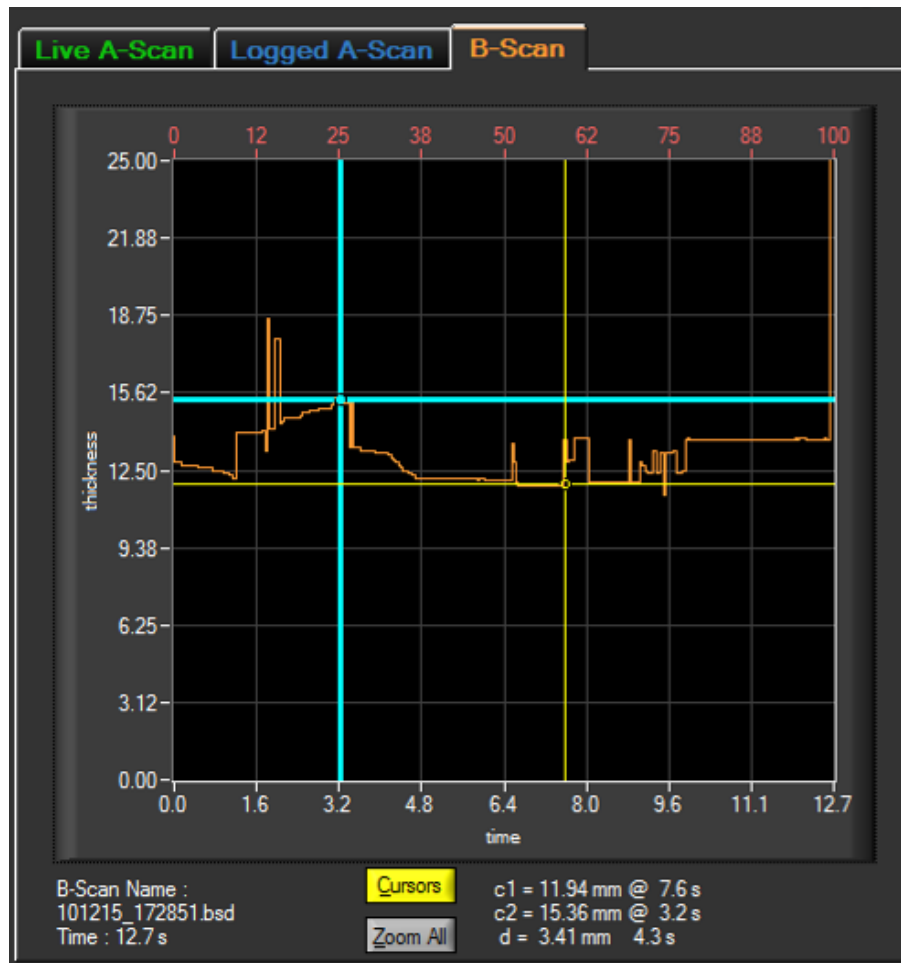

B-Scan Graph with Cursors

The values of the two cursors (c1 = yellow, c2 = blue) are displayed to the right of the Cursor button along with the difference between the two cursors for relative measurements (d).

Zooming the B-Scan Graph

You can Zoom into the B-Scan graph by holding the **CTRL key** down while using the mouse to draw a zoom area while holding the **Left mouse button**.

You can use the **Zoom All** button to zoom back to the whole B-Scan.

Viewing a B-Scan Information

To view information about the B-Scan click the Properties item from the context menu, a screen will display the properties;

Details	
Gauge Type	M5-C6
Gauge ID	01
Serial No	020000
Units	mm
Probe	T2C
Measurement Mode	Single Echo
Minimum Thickness	11.55 mm
Velocity	5920
Temp Comp.	Off
Scan Points	386
Scan Time	12.7 s
Scan Interval	33 ms
Scan Length	100
Date	10-Dec-15 17:28

B-Scan Properties Screen

Exporting the B-Scan to a CSV File

The B-Scan data can be exported to a CSV file which can be read into a spreadsheet or other application, click the Export to CSV File option from the context-menu after selected the required B-Scan in the list.

K19							
	A	B	C	D	E	F	G
1	B-Scan Details						
2		Name	101215_172851.bsd				
3		Notes					
4		Date	10/12/2015 17:28				
5		Points	386				
6		Units	mm				
7		Probe	T2C				
8		Mode	SE				
9		Scan Length	100				
10		Velocity	5920				
11		Minimum	11.53				
12				Scan Points			
13				No	Time(s)	Thickness	
14				1	0	13.9	
15				2	0.03	12.8	
16				3	0.07	12.8	
17				4	0.1	12.8	
18				5	0.13	12.8	
19				6	0.17	12.7	
20				7	0.2	12.7	
21				8	0.23	12.7	
22				9	0.26	12.7	
23				10	0.3	12.7	
24				11	0.33	12.7	
25				12	0.36	12.7	
26				13	0.4	12.7	
27				14	0.43	12.7	
28				15	0.46	12.7	
29				16	0.49	12.6	
30				17	0.53	12.6	
31				18	0.56	12.6	
32				19	0.59	12.6	

B-Scan Data Exported to CSV file and opened in Excel

Measurement Comment List

The Measurement Comment List is a list of 8 pre-set text comments that can be added to data logged measurement points. The C6+ gauge also holds a copy of these comments for use during data logging. You can edit these comments using CygLink then send them to the gauge when connected to CygLink.

1. From the Menu click;
File
 ↳ **Measurement Comments**

2. You can then Add, Edit, or Remove the entries in the comment list

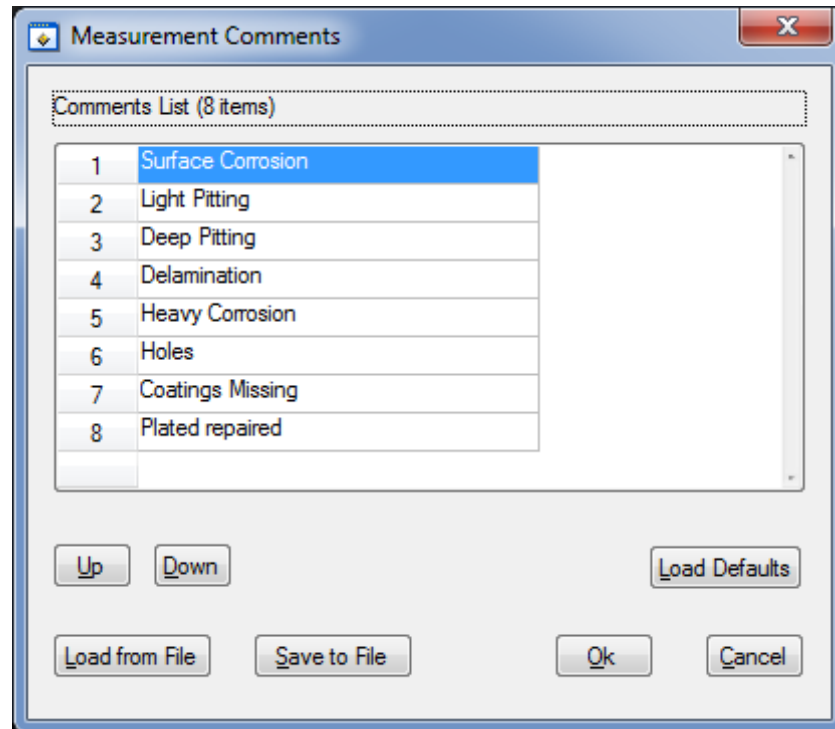

3. To send the new comments to the gauge, from the Menu click;
Gauge
 ↳ **Transfer Measurement Comments to Gauge**

The gauge will display a conformation message when the new comments list has been received successfully.

Material Velocity List

The Material Velocity List is a table of materials along with their velocity of sound value. CygLink comes with a pre-defined list but you can create your own list of materials specifically to suit your application. This list can be send to the gauge when connected to CygLink.

1. From the Menu click;
File
 └ Material Velocity List

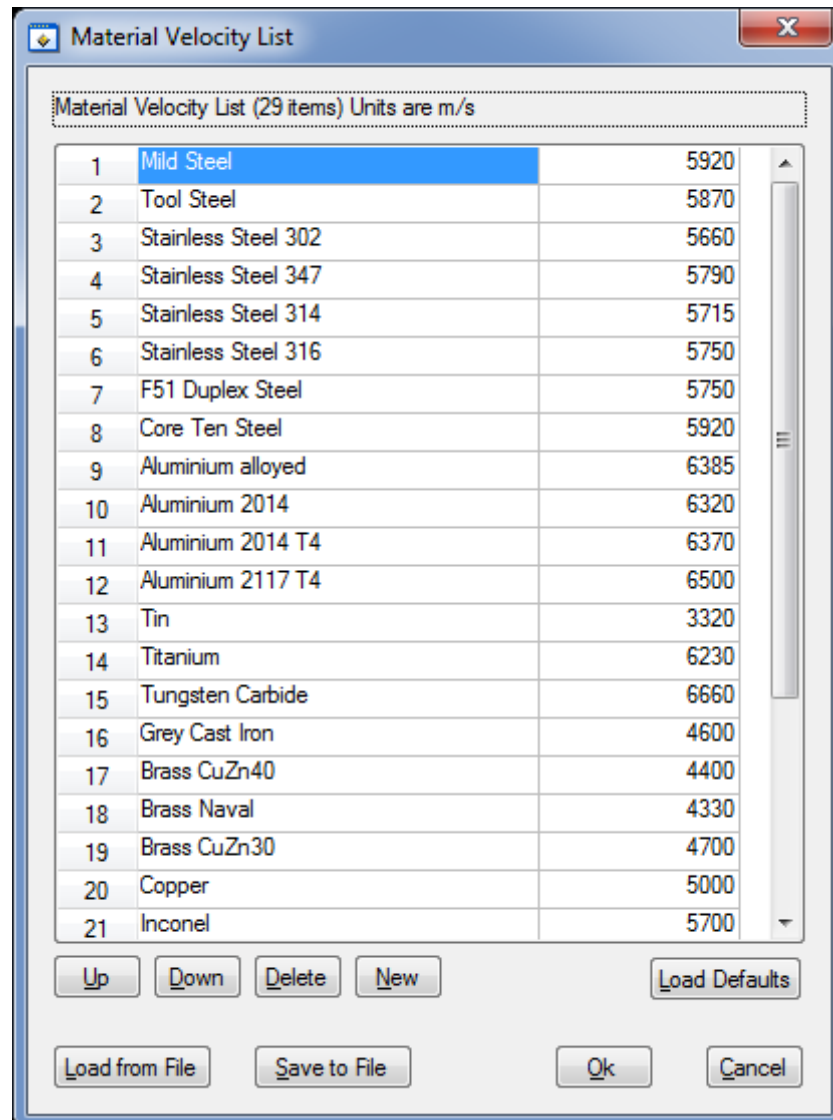

2. You can Edit, Add, Delete or Re-arrange the items in the list.

Note the velocity is in metric (m/s) by default. You can edit the table in imperial (in/μs) by setting the Measurement Units to Inch from the Setup – Measurement Setup item.

3. To send the velocity list to the gauge, from the Menu click;
Gauge
 └ Transfer Material Velocity List to Gauge

The gauge will display a conformation message when the new velocity list has been received successfully.

Creating a PDF Survey Report

A PDF report can be produced containing all the Survey Records and thickness measurements in the Survey, grouped by each Survey Records. Once the export process is complete, your report will automatically be displayed in your installed PDF viewer. The export may take a few seconds, depending on the number of measurements contained in the survey.

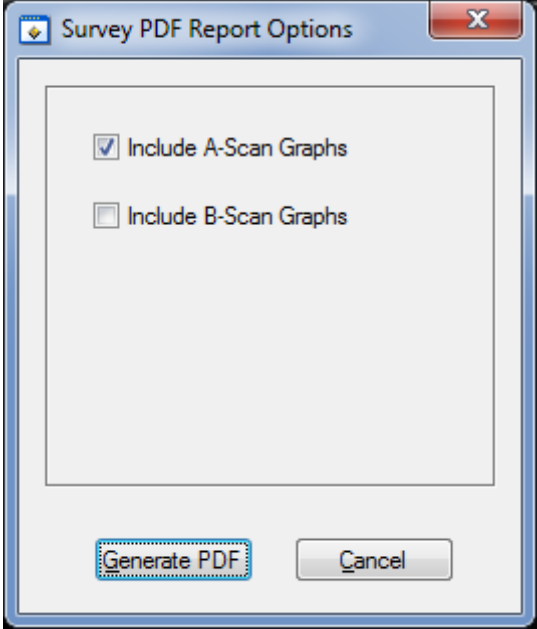
<p>1.</p>	<p>From the Menu click; File └ Create Survey Report PDF</p>	
<p>2.</p>	<p>You can choose to include A-Scan and/or B-Scan graphs in the report.</p>	
<p>3.</p>	<p>A report filename may be suggested, you can continue with the filename or type your own as required.</p>	

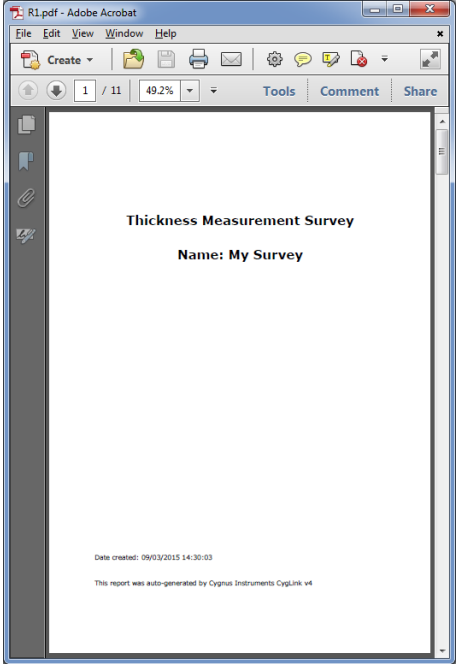
<p>4.</p>	<p>The report is then created and will open in your PDF viewer.</p>	
<p>5.</p>	<p>The PDF report is arranged into the following sections;</p> <ul style="list-style-type: none"> • Title Page • Survey Details Page • Survey Record details and measurements for each survey • Appendix of all the A-Scan Graphs • Appendix of all the B-Scan Graphs 	

Exporting a Survey to a CSV File

You can export the textual and numeric data from the whole survey to a CSV⁵ file that can be opened with a spreadsheet such as Microsoft Excel. An example of a CSV export opened in Excel is shown below;

<p>1.</p>	<p>From the Menu click; File └ Export Survey to CSV File</p>
<p>2.</p>	<p>A filename may be suggested, you can continue with the filename or type your own as required.</p>

⁵ CSV - Comma Spaced Variable

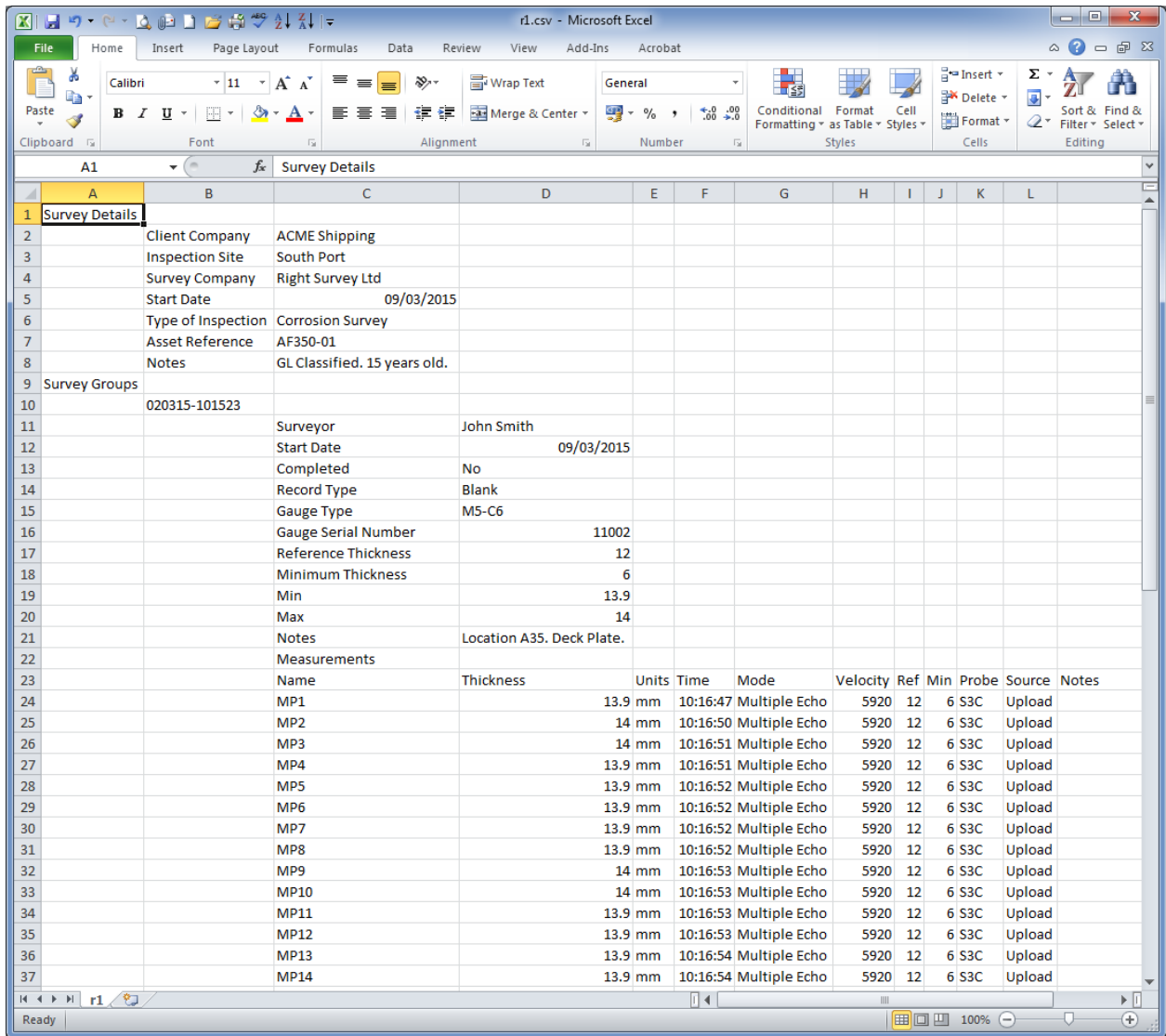

Survey CSV Export opened in Excel.

Templates

Creating New Templates

1. To create a new Templates, from the Menu click;
 - Setup
 - └ New Template

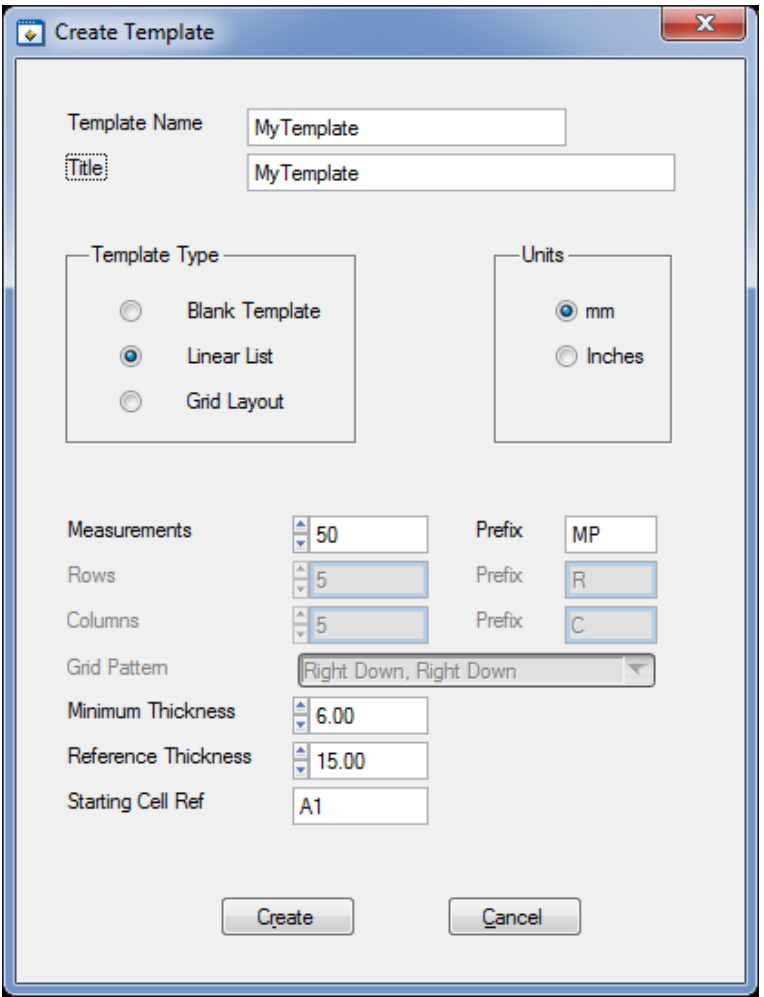
<p>2. You can select various options at this stage such as the layout of the template, its units and how many measurement points it will have.</p> <p>Click Create to generate the template</p>	
<p>3. The new template is opened in the Edit Template screen where you can further arrange the contents and add User Fields if required.</p>	

Editing Templates

You can Edit (or Delete) a Template from the **Setup-> Manage Templates** menu item. You can read more about Templates in Data Logging Templates on page 100

<p>1.</p>	<p>To view a list of the Templates, from the Menu click; Setup └ Manage Templates</p>
<p>2.</p>	<p>The Template Manager screen lists all your Templates. Here you can Delete or Edit the selected Template.</p>

3.

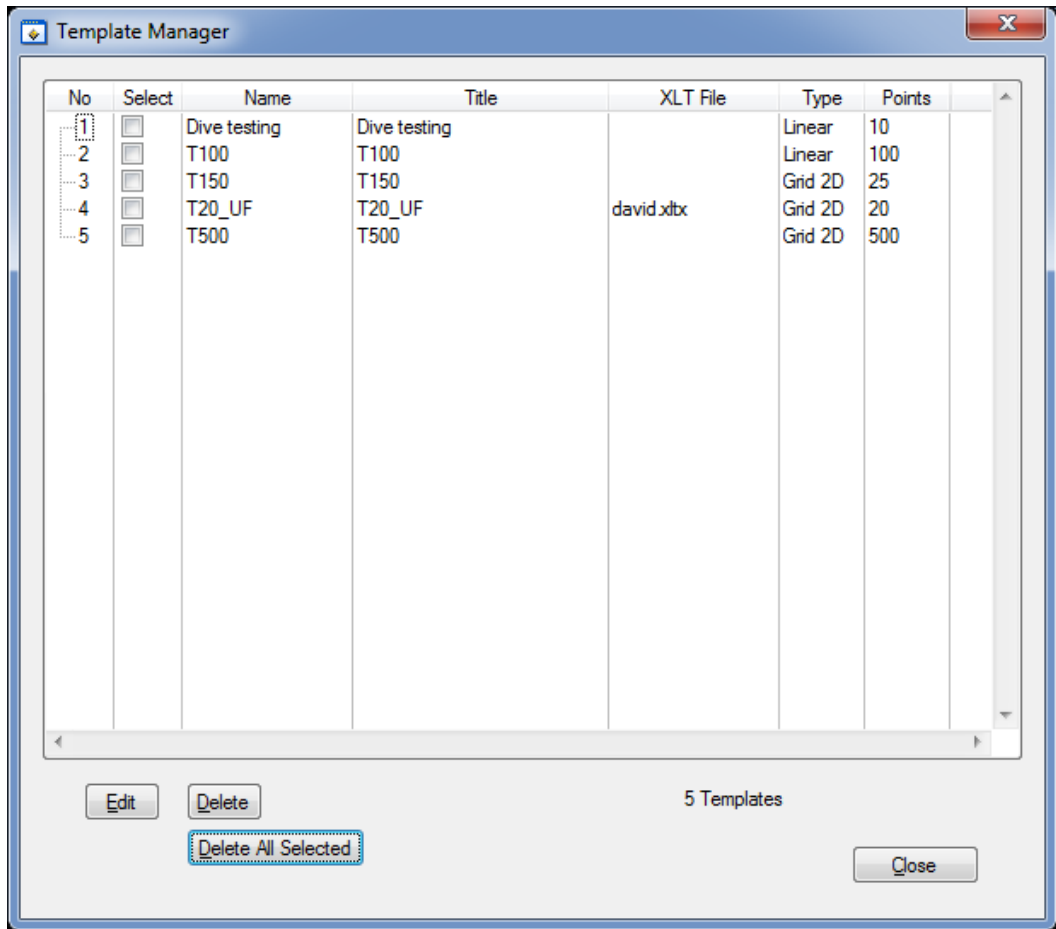

Editing the Template.

4. There are 4 tabs that group various sections of the Template.

Details : Name, Reference Minimum, Units, Velocity

Excel Template : Optional spreadsheet cell locations

Measurement Points : Thickness measurement points

User Fields : User field items

5. The **Details** tab contains the basic settings such as Units and the default velocity of sound value. You can also specify a Reference and Minimum thickness value and apply to all the measurements.

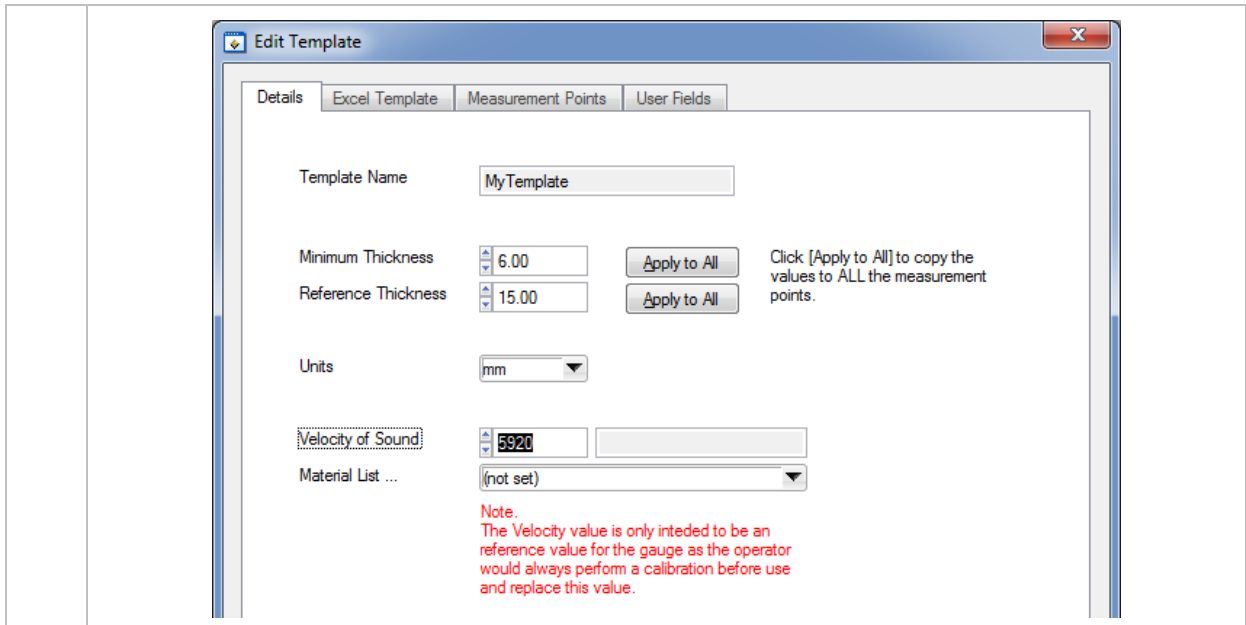

6. The **Measurement Points** tab lists each thickness measurement point in the order they will be taken. You can set the name, reference and minimum thicknesses and spreadsheet cell location.

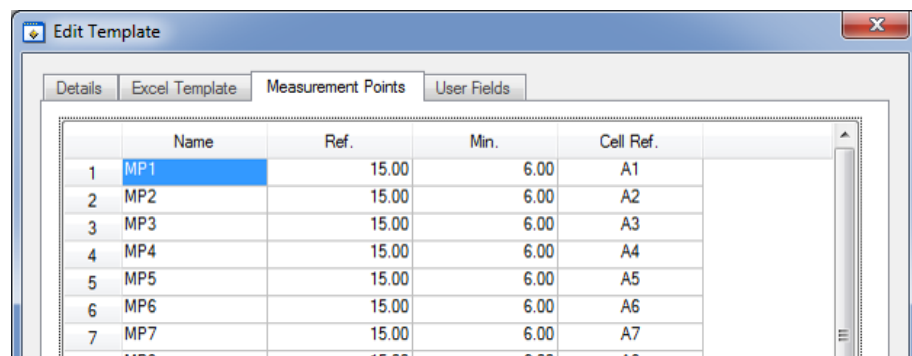

7. **User Fields** can be added by clicking the **New** button. You must then enter a Name, Cell location and select a Type.

If using the 'List' type click on the **List** button to edit the list of text items.

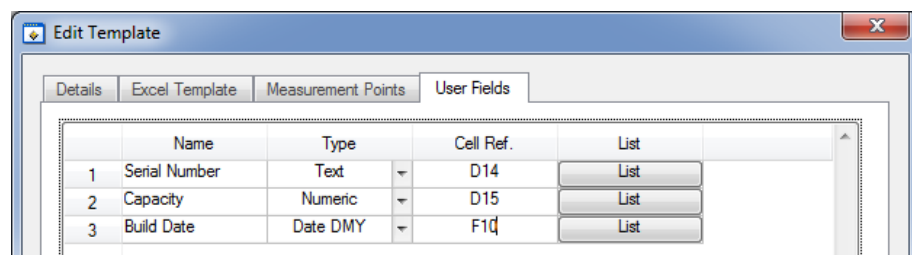

8. When your template is complete click **Save** to save the template. Your new template will appear in the Template Managers list.

Sending Templates to the Gauge

1. To send Templates to the gauge, from the Menu click;
Gauge
↳ **Transfer Templates to Gauge**
2. You will see the **Template Manager** screen. Select the template you wish to send to the gauge by clicking the **Select** checkboxes required.

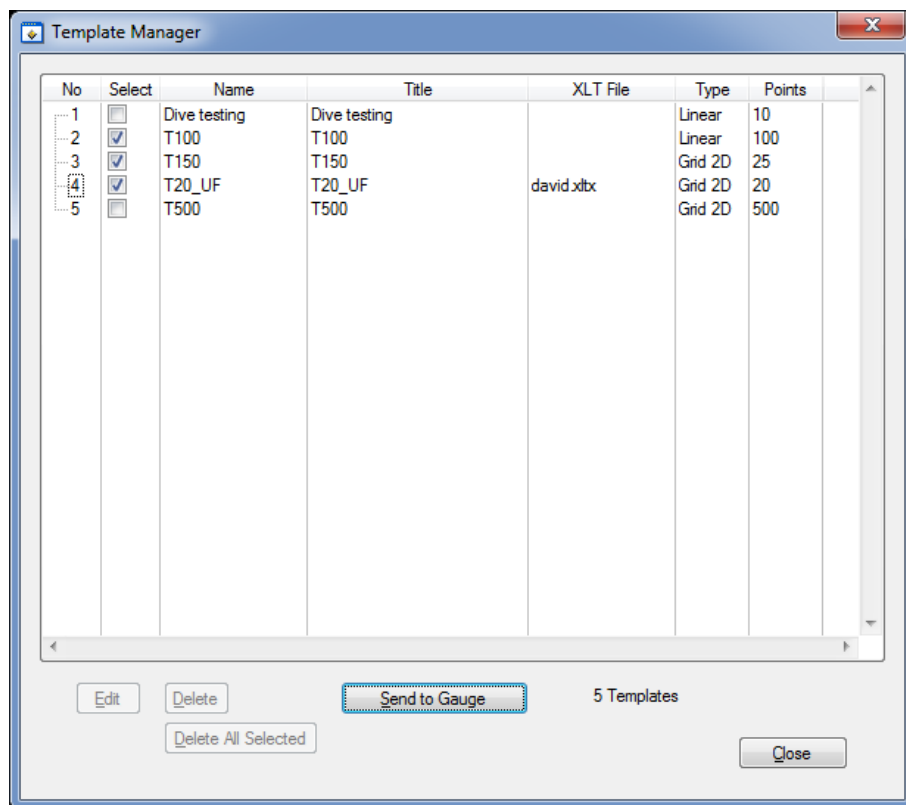

3. To start sending click the **Send to Gauge** button
4. The gauge will display a progress message while the template are being transferred

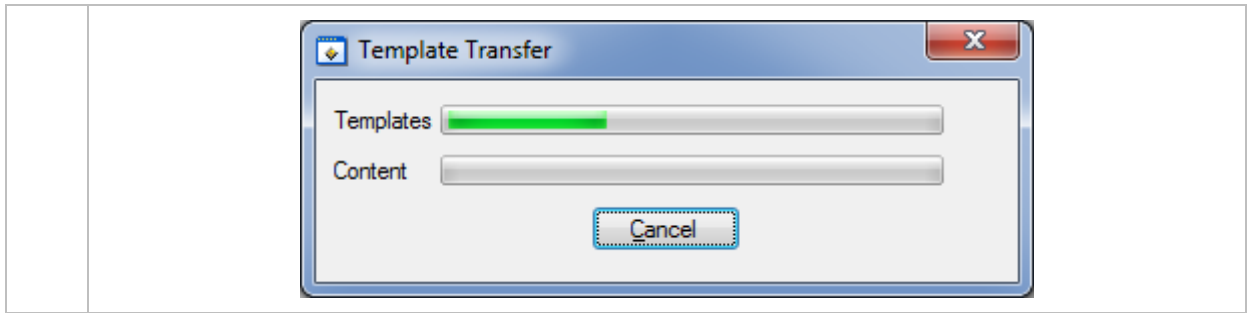

Deleting Templates from the Gauge

1. To delete all the Templates from the gauge, from the Menu click;
Gauge
 ↳ **Delete all Templates in Gauge**
2. The gauge will display a conformation message when the Templates has been deleted successfully.

Other Features

Setting the Time and Date on the Gauge

You can send the computers current Time and Date to the connected gauge so it can update its internal clock calendar.

1. To set the Time and Date in the gauge, from the Menu click;
Gauge
 ↳ **Set Time and Date in Gauge**

COM Port Numbers

CygLink should automatically find the COM port number assigned to the USB converter when you click "Connect" so you don't need to search for the port number Windows has assigned.

Finding your COM Port Number

With the USB lead plugged into your computer, open Windows Device Manager – to do this press the Windows® key  and the 'R' key together, then type "**devmgmt.msc**" into the prompt

followed by enter key. In the **Ports** section, look for the USB Serial Port entry. Remember the COM number listed as this will need to be selected within CygLink's settings menu.

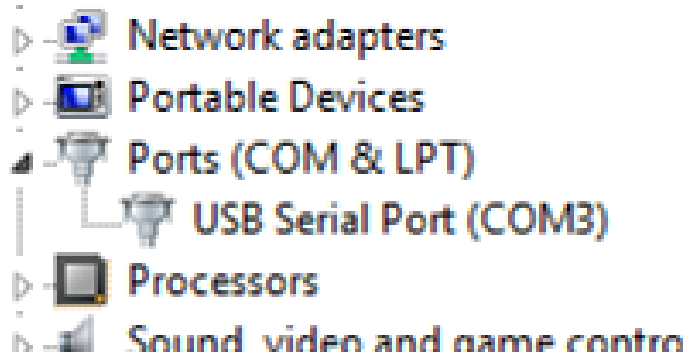
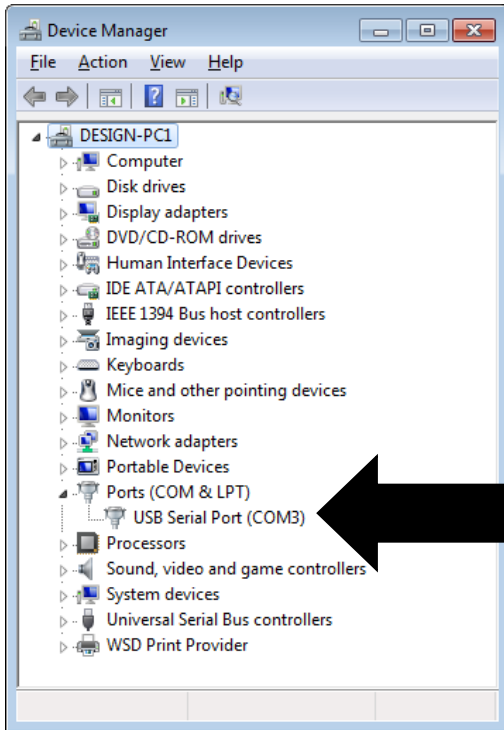

Windows® Device Manager

21. Information

Technical Specifications

Cygnus M5-SG Technical Specifications	
General Attributes	
Size	84 mm x 130 mm x 35 mm (W x H x D) (3.3 in x 5.1 in x 1.4 in)
Weight	Gauge with batteries 300 g (10.5 oz.)
Power Supply	3 x AA / R6 Batteries.
Probe Sockets	2 x Lemo 00
Operating Temperature Range	-10°C to +50°C (14°F to 122°F)
Storage Temperature Range	-10°C to +35°C (14°F to 95°F)
Battery Operation Time	Approximately 10 hrs. of measurement with fully charged Duracell Alkaline LR6 batteries.
Battery Voltage Range	Min 3.0 V dc, Max 4.5 V dc
Battery Type	AA Size. LR6 Alkaline / HR6 NiMH.
Low Battery Indication	Battery level indication on display with low battery warning message.
PRF	N/A
Monitor Outputs	N/A
Through Coating Measurements	Multiple-Echo mode with Single element 0° probe; <ul style="list-style-type: none"> • Through coating measurement for coatings up to 3 mm thick as standard depending on coating velocity. • Deep Coat mode provides ability to measure through thicker coatings depending on coating material. Echo-Echo mode with Twin element probe; <ul style="list-style-type: none"> • Through coating measurement for coatings up to 1 mm thick as standard depending on coating velocity.
Materials	Sound velocity from 1000 m/s to 9000 m/s [0.0390 in/us to 0.3543 in/us]

Cygnus M5-SG Technical Specifications			
Measurement Ranges (in steel)	Single element 0° probes in Multiple Echo mode;		
	S2C probe	3.0 to 250 mm	[0.120 in. to 10.00 in.]
	S3C probe	2.0 to 150 mm	[0.080 in. to 6.000 in.]
	S5C/A probes	1.0 to 50 mm	[0.040 in. to 2.000 in.]
	Twin element probes in Single Echo mode;		
	T2C probe	2.5 to 250 mm	[0.098 in. to 10.00 in.]
	T5B probe	1.5 to 200 mm	[0.059 in. to 7.900 in.]
	T7A probe	0.8 to 50 mm	[0.031 in. to 2.000 in.]
	T5A probe	1.5 to 200 mm	[0.059 in. to 7.900 in.]
	T5B-MAUH (T5BH) probe	1.5 to 150 mm	[0.059 in. to 6.000 in.]
	Twin element probes in Echo-Echo mode;		
	T2C probe	5.0 to 36 mm	[0.200 in. to 1.440 in.]
	T5B probe	2.5 to 36 mm	[0.160 in. to 1.440 in.]
	T7A probe	1.0 to 25 mm	[0.120 in. to 1.000 in.]
	T5A probe	1.5 to 36 mm	[0.160 in. to 1.440 in.]
T5B-MAUH (T5BH) probe	4.0 to 20 mm	[0.160 in. to 0.780 in.]	
Probe Zero	<p>Twin element probes are zeroed in the air without the need of a zero block. The user is prompted to zero the probe at power up and after a probe change.</p> <p>Single element probes in multiple echo mode do not need to be zeroed.</p>		
Measurement Modes	<p>Single Echo mode with Twin element probe. Measures thickness using the time from the delay line (zero point) to the first back-wall echo. (UT Mode 2)</p> <p>Echo-Echo mode with Twin element probe. Measures thickness using the time between the first and second back-wall echoes. (UT Mode 3)</p> <p>Multiple Echo using Single element probe. Uses three matched and verified back-wall echoes to determine the material thickness and ignore surface coatings.</p>		
High Temperature Measurement	<p>All standard single element and twin element probes: Allows continuous measurement up to 75°C (160°F).</p> <p>T5BH (T5B-MAUH) probe: Allows continuous measurement up to 350°C (662°F) and measurement with intermittent surface contact to 550°C (1022°F). Compensation for velocity change at high temperature using ASME rule "Reduce 1% per 55°C (100°F)"</p>		
Measurement Technology	Zero-crossing detection with interpolation.		

Cygnus M5-SG Technical Specifications			
Resolution	Single Echo and Echo-Echo measurement modes;		
	Low	0.1 mm	[0.005"]
	High	0.01 mm	[0.001"]
	Multiple Echo measurement modes;		
	Low (measurement > 120 mm)	0.1 mm	[0.005"]
	Medium (measurement < 120 mm)	0.05 mm	[0.002"]
Accuracy	<p>± 0.05 mm (± 0.002") - in Multiple-Echo measurement mode, when calibrated and measuring the same material as calibrated on.</p> <p>± 0.1 mm (± 0.004") or 0.1% of thickness measurement whichever is the greatest - in Single-Echo & Echo-Echo measurement modes, when calibrated and measuring the same material as calibrated on.</p>		
Display			
Type of Display	Colour TFT LCD with LED Backlight (front) and monochrome LCD (end).		
Side Display	TFT : 320 x 240 Pixels QVGA. 2.4", 47 mm (W) x 37 mm (H)		
End Display	LCD : 128 x 32 Pixels. 25.58 mm (W) x 6.38 mm (H)		
Display Information	Digital Thickness Value. Battery Level. Settings. Where available - A-Scan. B-Scan. Logged Measurements.		
Transmitter			
Shape of Pulse	Square		
Pulse Energy : Voltage (peak-to-peak)	70 V p-p		
Pulse Energy : Rise Time	3 ns (max)		
Pulse Energy : Pulse Duration	S2C : 220 ns S3C : 100 ns S5A / S5C : 67ns T2C : 220 ns T5B : 100 ns T5A : 100 ns T7A : 67 ns T5BH : 100 ns		
Receiver			
Gain Control	Automatic Gain Control depending on probe and measurement mode (default). Manual Gain control option in 1dB steps from 20 to 70 dB		
Frequency Range	1.0 MHz to 10.0 MHz (-6dB)		
Other Information			
Data Output and Storage	Data stored on removable micro-SD card. Data output via USB serial connection to computer.		

Cygnus M5-SG Technical Specifications	
Data Connector	USB Mini B Connector under battery cover. Can be used to update the gauge firmware and load gauge settings.
Data Logger	Maximum number of measurement points per Record : 5000 Maximum number of Records : 100 (soft limit) Maximum Grid Record size : 100 rows x 50 columns Maximum number of User Data Fields : 40 Maximum number of Template measurement points : 5000 Data stored on removable micro-SD card formatted for Windows (FAT32). Supplied 8 GB.
Cross-Section B-Scan Function	Scan Rate SE Mode : 30 Measurements per second Scan Rate EE Mode : 15 Measurements per second Max. Points : 5000 (166 seconds in SE Mode).
Calibration setting storage	Calibration Data stored to Internal Flash Memory
Calibration Mechanisms	Not required for Multiple Echo mode. Automatic V-path correction for twin element probes. Option of two-point calibration for twin element probes.
Display & Recall Facilities	N/A
Display Response Time	125 ms / 500 ms
Printer Output	N/A
Bluetooth <i>Cygnus 6+ models only</i>	Class 1. V4.1 +EDR. 10.5dBm TX Power. SPP/RFCOM Profile. Bluetooth Module Panasonic PAN1326B with Internal Antenna - Complies with Part 15 of the FCC Rules. - Class B digital device. - The device meets the requirements for modular transmitter approval as detailed in FCC public Notice DA00-1407 FCC ID T7V1316
Environmental Rating	IPX67 (Water immersion 1 metre depth for 30 minutes) MIL STD 810G Method 501.6 (High Temp +55°C) MIL STD 810G Method 502.6 (Low temp -20°C) MIL STD 810G Method 507.6 (Humidity 95%) MIL STD 810G Method 512.6 (Immersion 1m, 30min)
Shock & Impact	MIL STD 810G Method 514.7 (Vibration) MIL STD 810G Method 516.7 (Shock 20g) MIL STD 810G Method 516.7 (Transit Drop 1.22m)
Use in Explosive Atmospheres <i>Cygnus 4+ & Cygnus 6+ models only.</i>	Locations : Class I, Division 2, Group D only. Tested : MIL-STD-810G, Method 511.5, Procedure I. NOTE. This gauge is not Certified Ex (Intrinsically Safe) and therefore should NOT be taken into an Ex Zone.
Compliance	CE, UKCA, FCC, RoHS
Designed for	BS EN 15317

† Specifications are subject to change for product improvement.

Table of Sound Velocities

Velocities will vary according to the precise grade and processing conditions of the material being measured.



This table is included as a guide only.
Wherever possible, the Gauge should always be calibrated on the material under test.



These Velocities are given in good faith and are believed to be accurate within the limits described above.
No liability is accepted for errors.

Velocities given are the compressional wave velocity c_l .

Material	Velocity of Sound (V)		Conversion Factor (f)
	m/s	in/us	
Aluminium (alloyed)	6380	0.2512	1.078
Aluminium (2014)	6320	0.2488	1.068
Aluminium (2024 T4)	6370	0.2508	1.076
Aluminium (2117 T4)	6500	0.2559	1.098
Brass (CuZn40)	4400	0.1732	0.743
Brass (Naval)	4330	0.1705	0.731
Brass (CuZn30)	4700	0.1850	0.794
Copper	4700 - 5000	0.1850 - 0.1969	0.794 - 0.845
Core Ten	5920	0.2331	1.000
Grey Cast Iron	4600	0.1811	0.777
Inconel	5700	0.2244	0.963
Lead	2150	0.0846	0.363
Monel	5400	0.2126	0.912
Nickel	5630	0.2217	0.951
Phosphor Bronze	3530	0.1390	0.596
Mild Steel	5920	0.2331	1.000
Tool Steel	5870	0.2311	0.992
Stainless Steel 302	5660	0.2228	0.956
Stainless Steel 347	5790	0.2279	0.978
Stainless Steel 304	5664	0.2229	0.956

Stainless Steel 314	5715	0.2250	0.965
Stainless Steel 316	5750	0.1163	0.971
Tin	3320	0.1307	0.561
Titanium	6100 - 6230	0.2402 - 0.2453	1.030 - 1.052
Tungsten Carbide	6660	0.2622	1.125

Reading Conversions

If only a few measurements are to be taken on a material other than Steel, it may be easier to leave the calibration set for Steel and merely convert the readings by multiplying by the **Conversion Factor** for the material being measured.

This method avoids unnecessary recalibration.

Example.

The Gauge is calibrated for Steel [5920 m/s], but the reading is being taken on Copper [4700 m/s] :

$$\begin{aligned}
 T &= t \times V_{\text{COPPER}} / V_{\text{STEEL}} \\
 &= t \times 4700 / 5920 \\
 &= \underline{t \times 0.794}
 \end{aligned}$$

thus : **T = t x f** [where: f = $V_{\text{COPPER}} / V_{\text{STEEL}}$]

where : **T = true thickness of Copper being measured**
t = actual reading obtained
f = Conversion Factor (from table)

V_{COPPER} = Sound Velocity in Copper : 4700 m/s

V_{STEEL} = Sound Velocity in Steel : 5920 m/s

The **Conversion Factor f**: is given for various materials in the Table of Sound Velocities

22. Recycling and Disposal (EC Countries)

The WEEE Directive (Waste Electrical and Electronic Equipment 2002/96.EC) has been put into place to ensure that products are recycled using best available treatment, recovery and recycling techniques to ensure human health and high environmental protection.

The Gauge has been designed and manufactured with high quality materials and components which can be recycled and reused. It may contain hazardous substances that could impact health and the environment. In order to avoid the dissemination of those substances in our environment and to diminish the pressure on natural resources we encourage you to dispose of this product correctly.



DO NOT dispose of this product with general household waste.

DO dispose of the complete product including cables, plugs and accessories in the designed WEEE collection facilities.

This product may also be returned to the agent or manufacturer who supplied it for safe end-of-life disposal.

Cygnus Instruments Ltd registration number for The WEEE Directive is WEE/HE1274RU.

23. Warranty Information

Terms of Warranty

1. Product Registration

1.1 Cygnus Instruments Ltd. ("Cygnus") collaborates with all its resale partners, but resale of Cygnus products ("Products") by the Customer risks loss of traceability to end users of the Products. Manufacturer's support for the Products, including but not limited to firmware updates or product recall requirements, can only be provided by Cygnus with contact details of the end user, since support communication cannot be guaranteed via a resale partner or any other third party. Cygnus guarantees provision of proactive support and transfer of warranties for the Products to end users of the Products who register their Products at: <https://cygnus-instruments.com/service/product-registration/>

1.2 Cygnus stipulates that Product Registration as set out in paragraph 1.1 is a mandatory requirement for the Cygnus 1 Ex Ultrasonic Thickness Gauge in accordance with manufacturer responsibilities under the ATEX/IECEx/UKEX certification requirements.

1.3 All information relating to an individual person provided to Cygnus will remain confidential and protected under privacy policy terms found at: <https://cygnus-instruments.com/privacy-policy/>

2. Warranty

2.1 Subject to paragraph 3.2 and the following provisions, Cygnus warrants that:

- 2.1.1 the Products manufactured by it will correspond with their specification and be free from defects in material and workmanship for a standard period of three (3) years from the date of purchase from Cygnus;
- 2.1.2 except for batteries, probes, leads, microphones, telescopic extensions, which are warranted for six (6) months;
- 2.1.3 in the case of Products or equipment manufactured by a third party, Cygnus shall assign to the Customer the benefit of any warranty, guarantee or indemnity given by the company supplying the goods to Cygnus;
- 2.1.4 except for consumables, which are not warranted at all;
- 2.1.5 in the case of Equipment Service, the service will be provided using reasonable care and skill;
- 2.1.6 in the case of bespoke Products or which have (at the request of or by agreement with the Customer) been modified by Cygnus prior to sale, Cygnus warrants (subject as aforesaid) that any design or engineering services carried out by Cygnus will be supplied with reasonable care and skill.

2.2 The warranties referred to above are given by Cygnus, who shall, at its option, repair, replace or refund the price of the defective Products in full, provided:

- 2.2.1 the Customer gives notice in Writing during the warranty period within a reasonable time of discovery that some or all of the Products do not comply with the warranty set out in paragraph 2.1;
- 2.2.2 the Customer returns such Products to Cygnus' place of business at the Customer's cost;
- 2.2.3 Cygnus is given a reasonable opportunity of examining such Products.

2.3 Cygnus shall be under no liability for the Products' failure to comply with the warranties if:

- 2.3.1 any defect in the Products arises from any drawing, design, specification information or instructions supplied by the Customer, or arises from their late arrival or non-arrival, or any other fault of the Customer;
- 2.3.2 the Customer integrates into any system, alters, modifies or repairs such Products without the prior written consent of Cygnus;
- 2.3.3 the defect arises because the Customer failed to follow Cygnus oral or written instructions as to the storage, installation, calibration, integration into a system, commissioning, use or maintenance of the Products or (if there are no such instructions) good trade practice;
- 2.3.4 the defect arises as a result of fair wear and tear, wilful damage, negligence, or abnormal working conditions;
- 2.3.5 the total price for the Products has not been paid by the due date for payment.

2.4 The warranty in this section 2 is the only warranty provided by Cygnus to the Customer in relation to the Products. All other statements, conditions, representations, warranties, whether express or implied, including any implied warranty of fitness for any particular purpose or satisfactory quality, are expressly excluded.

3. Products returned immediately after receipt

3.1 The Customer shall inspect the Products, or any instalment of the Products, immediately upon receipt. If the Products are damaged or do not comply with the warranty in paragraph 2.1, the Customer shall:

- 3.1.1 provide Cygnus with details of the problem with the Products in Writing; and
- 3.1.2 store the Products until it receives Cygnus' Written instructions in relation to the Products.

3.2 Cygnus' only liability and the Customer's sole right and remedy in respect of Products which at the time of delivery are damaged or do not meet the warranty in section 2 shall be at Cygnus' option either the supply of replacement Products (or the part in question) or a refund of the price paid (or a proportionate part of the price) to Cygnus in respect of such Products, in which case Cygnus shall have no further liability to the Customer. For the avoidance of doubt, Cygnus shall not be liable to the Customer for any damage to the Products, which occurs after the time of delivery, however the Customer may make a claim in respect of any such damage under the appropriate insurance policy.

4. Liabilities

4.1 Subject as expressly provided in these terms or in Cygnus' Terms of Sale, and except where the Products are sold to a person dealing as a consumer (within the meaning of the Unfair Contract Terms Act 1977), all warranties, conditions or other terms implied by statute or common law are excluded to the fullest extent permitted by law.

4.2 Except in respect of death or personal injury caused by Cygnus' negligence or liability for defective Products under the Consumer Protection Act 1987 Cygnus shall not be liable to the Customer by reason of any representation (unless fraudulent), or any implied warranty, condition or other term, or any duty at common law, or under the express terms of the Contract for purchase of the Products, for loss of profit or for any indirect, special or consequential loss or damage, costs, expenses or other claims for compensation whatsoever (whether caused by the negligence of Cygnus, its employees or agents or otherwise) which arise out of or in connection with the supply of the Products (including any delay in supplying or any failure to supply the Products in accordance with the Contract or at all) or their use or resale by the Customer. The entire liability of Cygnus under or in connection with the Products shall not exceed the price of the Products, except as expressly provided in these terms.

24. Index

- A-Scan
 - Auto Range, 108
 - Backwall Echo, 38
 - Range Adjustment, 106
- A-Scan Display, 38
- Automatic Power Off, 28
- Batteries
 - Fitting, 14
 - Level, 36
 - Life, 36
 - Low Battery Warning, 36
 - NiCad, 15
 - NiMH, 15
- Bluetooth, 109
 - Pairing, 110
 - Port Number, 112
- BS EN 15317:2007, 44
- Calibration
 - Conversion Factor, 161
 - Known Thickness, 44
 - Ladder Step Wedge, 46
 - Single Point, 44
 - Two Point Calibration, 46
 - Velocity of Sound, 51
- Chipping Hammer, 115
- CygLink
 - COM Port, 154
 - Drivers, 124
 - Requirements, 124
- Data Logging
 - Auto-Logging, 85
 - Grid Pattern, 79
 - Measurement Comments, 77
 - Minimum Alert, 76
 - Obstructions, 86
 - Points Taken, 85
 - Radial Points, 76
 - Re-Take, 88
- Deep Coat, 64
- Disposal, 162
- Echo-Echo, 20
- End Display, 31
 - Enable, 113
 - Rotate, 113
- Gain
 - dB Values, 103
 - Manual Gain, 103
- Gauge
 - Cleaning, 121
 - Display, 27
 - Keys, 27
 - Run Time, 28
 - Serial Number, 28
 - Version Number, 28
- High Temperature
 - Correction Factor, 68
 - General Formula, 67
 - Units, 113
- Ignore Coatings, 19
- Imperial, 59
- Main Menu, 53
- Measurement
 - Pitted surface, 115
- Measurement
 - Resolution, 60
 - Rough surfaces, 115
 - Small Pipes, 34
 - Stability, 33
 - Units, 59
- Metric, 59
- Multiple Echo, 19
 - Echo Bars, 32
- Neck Strap, 17
- Plastics, 21

- Power button, 28
- Probe Zero, 31
- Probes
 - Automatic Detection, 58
 - Connector, 27
 - Knurled Ring, 24
 - Membrane Couplant, 24
 - Membrane Key, 24
 - Polyurethane Membrane Membrane, 22
 - Type, setting, 57
 - Zero, 49
- Recycling, 162
- Repair, 122
- Resolution, 60
- Scan
 - Average, Min, Max, 71
 - Cross-Section Scan, 71
- Service, 122
- Single Echo, 19
- Sound Velocities, 160
- Templates
 - Creating new Records, 83
 - User Field Input, 83
- Test block, 44
- Thick Coatings, 64
- Thickness Measurement, 31
- Through Coating, 19
- Troubleshooting, 116
- Units, 59
- USB Port, 123
- Vibrate
 - Turn On/Off, 108
- Warranty, 163
- WEEE Directive, 162
- Zeroing, 49